



Emulations

Applications Manual

6800 Series Printers

Trademark Acknowledgements

Acrobat® Reader is a trademark of Adobe Systems Incorporated.

DEC is a trademark of Compaq Computer Corp.

Epson is a trademark of Seiko Epson Corp.

Genicom is a trademark of Genicom L.L.C.

HP is a trademark of Hewlett-Packard Company.

IBM and Proprinter are trademarks of International Business Machines Corporation.

Printronix and PGL are trademarks of Printronix, LLC.

QMS and Code V are trademarks of Minolta-QMS Inc.

TallyGenicom brand is owned by Printronix, LLC.

COPYRIGHT 2010, 2012 PRINTRONIX, LLC.

Table of Contents

1	Control Language Emulations.....	5
	Tally ANSI.....	6
	Character Definition And Format	6
	Page Formatting	20
	Paper And Print Position Movement.....	26
	Plot Mode	32
	Miscellaneous Functions.....	40
	Reserved Control Codes.....	43
	Escape Sequence Summary	45
	Genicom ANSI.....	47
	Emulation Definition	47
	Emulation Exceptions	78
	Emulation Enhancements	80
	Printronix P5000	80
	Printronix P6000	81
	Printronix P600	81
	HP 2564C	81
	Emulation Enhancements	84
	DEC LG01	84
	Epson FX-1180.....	85
	IBM Proprinter III XL	87
	MTPL	87
	Emulation Differences	88
	Emulation Enhancements	90
	PJL.....	90
2	Graphics Language Emulations.....	93
	MT660 Industrial Graphics	93
	QMS Code V	93
	Printronix Graphics Language.....	93
3	Intellifilter	95
	Filter Structure and Logic	95
	Filter Procedure for Matching Targets.....	96
	Target Matching Rules	96
	Building, Testing, and Implementing Intellifilter	97
	IFILTER.EXE.....	98
	BUILDL0D.EXE	98
A	Contact Information	99

TallyGenicom Customer Support Center	99
TallyGenicom Supplies Department	99
Corporate Offices	100

1 *Control Language Emulations*

A number of printer control language emulations provide compatibility with existing applications and reduce host programming efforts. The default emulation is Tally ANSI.

When an emulation is selected, the following parameters are set to a default condition required by the emulation:

Parameter	Tally ANSI	Genicom ANSI	P5000	P6000	P600
Character Set	Latin 1	Code Page 437	Code Page 437	Latin 1	Latin 1
OCR-A	ANSI	ANSI	ANSI	ANSI	ANSI
OCR-B	ANSI	ANSI	ANSI	ANSI	ANSI
Auto CR	OFF	ON	ON	ON	OFF
Line Wrap	OFF	ON	OFF	OFF	OFF
Wrap LF	OFF	ON	OFF	OFF	OFF
Code 7F	Fill	Fill	Space	Space	Space
VT Channel	2	12	N/A	12	12
Skip When	Before	Before	N/A	After	After

Parameter	HP 2564C	DEC LG01	Epson FX-1180	Proprinter III XL	MTPL
Character Set	HP Roman-8	DEC Multinat'l	Italic	Code Page 437	Code Page 437
OCR-A	ANSI	ANSI	ANSI	ANSI	ANSI
OCR-B	ANSI	DIN	ANSI	ANSI	ANSI
Auto CR	OFF	OFF	ON	ON	ON
Line Wrap	OFF	OFF	ON	ON	ON
Wrap LF	OFF	OFF	ON	ON	ON
Code 7F	Fill	Fill	Del Char	Ignore	Del Buffer
VT Channel	N/A	12	N/A	N/A	12
Skip When	N/A	After	N/A	N/A	After

Optional Emulations

Parameter	HP LineJet	DEC LG+
Character Set	HP Roman-8	DEC Supp.
OCR-A	ANSI	ANSI
OCR-B	ANSI	ANSI
Auto CR	OFF	OFF
Line Wrap	OFF	OFF
Wrap LF	OFF	OFF
Code 7F	Fill	Space
VT Channel	N/A	N/A
Skip When	N/A	N/A

Tally ANSI

This language is an emulation of the Tally MT660 native language, which was based on ANSI 3.64. It is the default emulation of the 6800 Series printers. This language has been enhanced as needed throughout the development of the 6800 Series printers.

Character Definition And Format

This section presents and explains the Reserved Control Codes and Escape Sequences that control how printed output will look, where it will print, characters that are available, etc.

Attributes, Print Position, and Type Styles

This escape sequence is used for setting up fonts by allowing you to control the print attributes (boldface, underline, overline, etc.), print position (superscript and subscript), and type style selection. The basic sequence is:

ESC	[n ₁	;	n ₂	;	n _x	m	ASCII Command
1B	5B	n ₁	3B	n ₂	3B	n _x	6D	Hex Equivalent

This sequence changes both the primary and secondary fonts, but does not change the character set selected except when changing into or out of the OCR sets. In this command you may combine codes for attributes, print positions, and type styles. You may send all of the attributes available and the printer will act on all of them. However, when you send type style codes and super- and subscript codes, the printer will act only on the last type style code and whichever of the super- and subscript commands appears last.

The codes in the following lists may be listed in any order in the command. Each code must be separated from the following code by a semicolon.

Using this escape sequence, you can select such things as Italicized Courier font by sending a code to select the Courier type style along with a code to select italic printing (see Table 1 on page 7 for an explanation of combining character definition and format codes).

The codes in Table 1 may be listed in any order in the command. Each code must be separated from the following code by a semicolon.

Table 1 Character Definition and Format Codes

Parameter Code		Parameter Description
ASCII	HEX	
Attribute Selections		
4	34	Underline
3	33	Italic
1	31	Boldface
60	3630	Overline
61	3631	Strikethrough
0	30	End Attribute
Print Position		
62	3632	Superscript printing
63	3633	Subscript printing
0	30	End Super-/subscript
Type Styles		
10	3130	Data Processing
11	3131	Gothic
12	3132	OCR-A (ANSI & DIN)
13	3133	OCR-B (ANSI & DIN)
14	3134	Draft
15	3135	Courier
19	3139	Downloaded Font

Combining Attributes

Any of the attributes discussed in the ESC [nm sequence may be included in a single escape sequence. The escape sequence begins the same as one requesting a single code but changes after the first attribute byte. A semicolon (;) must be inserted between each code listed in the sequence. For example, to print a single word in a sentence with the boldface and underline attributes, send the following escape sequence

ESC	[1	;	4	m
1B	5B	31	3B	34	6D

immediately before the word in the data stream and follow the word with the escape sequence:

ESC	[0	m
1B	5B	30	6D

Example: To boldface and italicize the word "only" in the sentence:

Enter: Boldface and italicize the word ESC[1;3monlyESC[0m in this sentence.

Printer Output: Boldface and italicize the word ***only*** in this sentence.

Languages and Character Sets

The numerous language and character set selections are defined in the Character Sets section of this manual. The following commands can be used:

Table 2 Language and Character Set Selections		
Language	Tally ANSI G0	Tally ANSI G1
ISO 2 - IRV	ESC (@	ESC)@
ISO 4 - UK	ESC(A	ESC)A
ISO 6 - US	ESC(B	ESC)B
ISO 10 - Swed/Fin Basic	ESC(G	ESC)G
ISO 11 - Swedish/Finnish	ESC(H	ESC)H
ISO 14 - Japanese	ESC(J	ESC)J
ISO 15 - Italian	ESC(Y	ESC)Y
ISO 16 - Portuguese	ESC(L	ESC)L
ISO 17 - Spanish	ESC(Z	ESC)Z
ISO 21 - German	ESC(K	ESC)K
ISO 60 - Nor/Danish	ESC('	ESC)'
ISO 69 - French	ESC(f	ESC)f

Table 2 Language and Character Set Selections		
Language	Tally ANSI G0	Tally ANSI G1
Canadian	ESC(w	ESC)w
Hungarian	ESC(i	ESC)i
Chinese	ESC(T	ESC)T
French T6	ESC(2	ESC)2
Swedish/Finnish T6	ESC(3	ESC)3
Italian T6	ESC(4	ESC)4
Canadian Alternate	ESC(x	ESC)x
French Withdrawn	ESC(R	ESC)R
Nor/Danish T6	ESC(5	ESC)5
ISO 8859-1 - Latin 1	ESC,A or ESC(%	ESC-A or ESC)%
ISO 8859-2 - Latin 2	ESC(&	ESC)&
ISO 8859-5 - Cyrillic	ESC(*	ESC)*
ISO 8859-7 - Greek	ESC(-	ESC)-
ISO 8859-9 - Turkish	ESC(.	ESC).
ISO 8859-15 Latin 9	ESC(/	ESC)/
Code Page 437 - IBM Proprinter	ESC(0x80	ESC)0x80
Code Page 850 - Latin 1	ESC (0x82	ESC)0x82
Code Page 851 - Greek	ESC(0x88	ESC)0x88
Code Page 852 - Latin 2	ESC(0x87	ESC)0x87
Code Page 855 - Russian Cyrillic	ESC(0x8A	ESC)0x8A
Code Page 857 - Turkish	ESC(0x8D	ESC)0x8D
Code Page 863 - French Canadian	ESC(0x85	ESC)0x85
Code Page 866 - Cyrillic	ESC(0x8E	ESC)0x8E
Code Page 1250 - Win 98 Latin 2	ESC(p	ESC)p
Code Page 1251 - Win 98 Cyrillic	ESC(q	ESC)q
Code Page 1252 - Win 98 Latin 1	ESC(r	ESC)r
Code Page 1253 - Win 98 Greek	ESC(s	ESC)s
Code Page 1254 - Win 98 Turkish	ESC(t	ESC)t
DEC Multinational	ESC(<	ESC)>
DEC Turkish	ESC(y	ESC)y

Table 2 Language and Character Set Selections		
Language	Tally ANSI G0	Tally ANSI G1
Siemens Turkish	ESC(z	ESC)z
HP Roman-8	ESC(0x83	ESC)0x83
ISO Katakana - ISO 13	ESC(1	ESC)1
Line Draw	ESC(7	ESC)7
SAP 8859-1	ESC(+	ESC)+
SAP 8859-2	ESC(,	ESC),
SAP 8859-5	ESC(#	ESC)#

Primary and Secondary Fonts and Languages

This escape sequence allows a font style and some language substitutions to be loaded into the primary (G0) and secondary (G1) areas. To load your primary and alternate character sets, use the sequence:

ESC	[n ₁	;	n ₂	!	s
1B	5B	n ₁	3B	n ₂	21	73

where:

n₁ = the value field for the primary (G0) character set.

n₂ = the value field for the alternate (G1) character set.

There are six groupings of Character Sets to select from on your printer.

Table 3 Language and Font Selections

Language	ASCII Values			
	Gothic	Courier	Draft	DP
(user default)	10	40	100 or 700	0
US	11	41	101 or 701	1
German	12	42	102 or 702	2
Norwegian/Danish-T6	13	43	103 or 703	3
French-T6	14	44	104 or 704	4
UK	15	45	105 or 705	5
Spanish	16	46	106 or 706	6
Swedish/Finnish-T6	17	47	108 or 708	7
Italian-T6	18	48	108 or 708	8
Special Characters	19	49	109 or 709	9
Downloaded Char. Set			700	

Table 4 Language and Font Selections

Language Sets	ASCII Values		
	OCR-A	OCR-B	Special Sets
OCR-A			
Default	600		
ANSI	601		
DIN	602		
OCR-B			
Default		610	
ANSI		611	
DIN		612	
Line Draw Char. Set			720

The following examples show how to use this escape sequence in a variety of ways.

Example 1:

To select US Data Processing as the primary set (n1 = 1) and Italian Data Processing as the alternate set (n2 = 8) use the escape sequence:

ESC	[1	;	8	!	s
1B	5B	31	3B	38	21	73

Example 2:

You may change to another primary set without changing the alternate set by omitting n2 in the sequence. For example, the original escape sequence shown above can be modified to:

ESC	[1	2	!	s
1B	5B	31	32	21	73

This escape sequence would change the primary character set to German Gothic (n1 = 12). The alternate character set remains unchanged.

Example 3:

To change the alternate character set to the Spanish Courier (n2 = 46) without changing the primary set, modify the escape sequence to:

ESC	[;	4	6	!	s
1B	5B	3B	34	36	21	73

Selecting Primary and Secondary Sets

There are two ways to access the primary and alternate character sets. Once the primary and alternate character sets are loaded, they can be accessed using the Shift In (SI, HEX 0F) and Shift Out (SO, HEX 0E) codes to select the sets for actual printing; SI selects the primary set, and SO selects the alternate set.

The second way to access the primary and alternate character sets uses the 8th bit to select either primary or alternate set. To use this method, set the 8th Bit Parameter to Data in the Configuration Menu. With 8th Bit set to Data, when the 8th bit is high, it performs the same function as the SO Command; it selects the Alternate Character Set. When the 8th bit is low, it performs the same function as the SI Command; it selects the Primary Character Set.

Downloading Fonts and Characters

The Tally ANSI Emulation includes a download font function that allows the user to download fonts and characters from the host computer.

When the printer is turned on or reset, the Download Font Memory is loaded with the Default Character Set. The user can replace any or all of these characters with downloaded characters.

To enter Download Font Mode use the escape sequence:

ESC	[<	2	h
1B	5B	3C	32	68

The Enter Download Sequence is followed by the Character Data Record, which defines the character and the memory location it will be downloaded to.

To exit Download Font Mode use the escape sequence

ESC	[<	2	l
1B	5B	3C	32	6C

NOTE: l = lower case L

Character Data Records

Each downloaded character is defined by a sequence of characters called a Character Data Record. These records follow the rules for the Intel HEX format. The format for each record is as follows:

:	<i>m</i>	<i>n₁-n₂</i>	<i>d</i>	<i>data</i>	<i>c</i>	CR	LF
---	----------	------------------------------------	----------	-------------	----------	----	----

where:

: = Record start. Every record starts with a colon (:). Every colon sent while in the Load Mode is interpreted as a start-of-record. Only Character Data Record bytes may be sent after a colon and before the checksum. Any other characters or control codes sent will be ignored except ESC and a colon. Each byte of the record that follows the colon is sent in hexadecimal format.

m = Number of bytes in record. The first byte of each record is the number of data bytes in that record. In this emulation this number is always 16 (HEX 10).

n₁ n₂ = The high- and low-order bits of memory load address. *d* = Record type (00 for data).

data = Dot pattern designators. Hexadecimal description of the dot patterns necessary for the character.

c = Checksum. This byte is used to check the data for accuracy.

Dot Matrix

Each character that will be downloaded is defined on the same 11x11 dot matrix used for the Data Processing Font (see Figure 1). Most characters use only the upper case rows and normal columns. Characters such as g, j, p, q, and y use the descender rows as well. Superscripts and characters with diacritics may use the ascender rows. Graphic characters that must join from side to side without a break use the left and right link columns.

In the Normal Columns area, adjacent horizontal dot positions will not print. If you do attempt to download adjacent dots among the normal columns, the printer will discard the right dot of each pair.

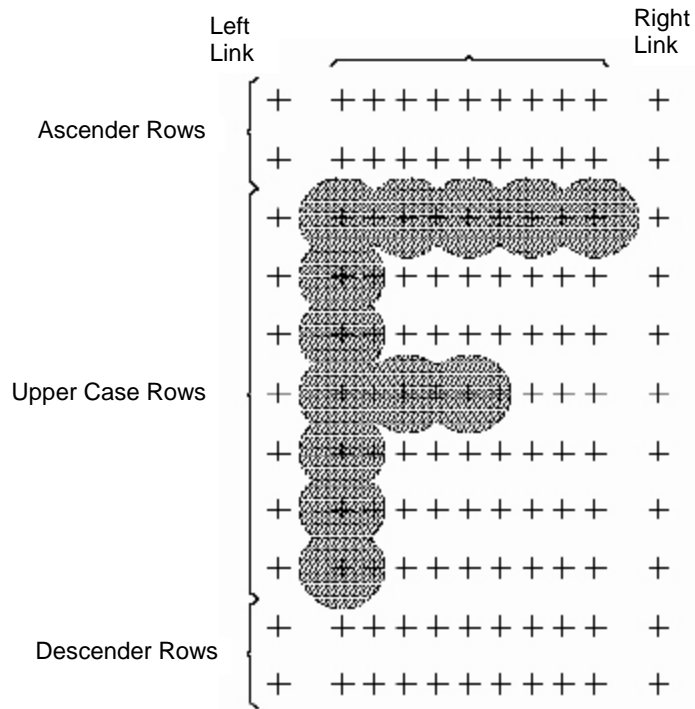

Figure 1 Download Dot Matrix

Computing the Memory Address

The second and third bytes are the memory addresses for the record location in download font memory. This address is determined by multiplying the ASCII code for the character by HEX 10. For special user-defined characters, select a character location in the ASCII basic set and use that location to compute the memory address. For example, to find the address for an upper- case k (K), multiply 4B (HEX value for K) by HEX 10. The second byte of the record would then be 04, and the third byte would be B0.

Converting Dot Matrix Data to Character Data

To convert the dot matrix image of the character in Figure 2 below perform the procedure that follows it:





Row 1		0000 000000000000
Row 2	+ + - + + - + - + -	000000000000
Row 3		00101010100
Row 4	+ + - +  - + - +	00000100000
Row 5	+ + - +  - + - +	00000100000
Row 6	+ + - +  - + - +	00000100000
Row 7	+ + - +  - + - +	00000100000
Row 8		00000100000
Row 9	+  +	00101010100
Row 10		000000000000
Row 11		000000000000 0000

Figure 2 Converting Dots to Binary

1. Convert each row to binary 1s (ones) and 0s (zeros), where a 1 represents a primary impact point (the center of the dot).
2. Rearrange the data into a linear form by putting the second row at the right side of the first row, the third row at the right side of the second, and so on to form one long sequence of bits. Add four 0 bits to the beginning of the line, and three 0 bits to the end of the line for a total of 128 bits in the sequence.

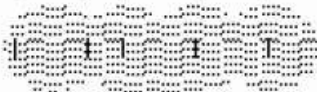
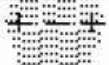
+4	Row 1	Row 2	Row 3....	Row 11	+3
0000	000000000000	000000000000	00101010100	000000000000	0110
Byte 1	Byte 2	Byte 3	Byte 16	

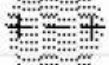
Figure 3 Downloaded Bit Sequence

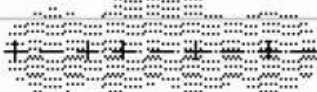
3. Convert the 128 bits to 16 bytes beginning at the leftmost 8 bits, which become Byte 1 (see above).
4. Reverse the sequence of bits in each byte as shown in Table 5.

Table 5 Binary Conversion and Sequence Reversal

Byte	Initial Binary #		Reversed Binary #		HEX
1	00000000	→	00000000	→	00
2	00000000	→	00000000	→	00
3	00000000	→	00000000	→	00
4	00001010	→	0000101	→	50
5	10100000	→	0000101	→	05
6	00100000	→	0000100	→	04
7	0000100	→	00100000	→	20
8	00000000	→	00000000	→	00
9	10000000	→	00000001	→	15
10	00010000	→	00001000	→	08
11	00000010	→	01000000	→	40
12	00000010	→	01000000	→	40
13	10101000	→	00010101	→	15
14	00000000	→	00000000	→	00
15	00000000	→	00000000	→	00
16	00000000	→	00000000	→	00

5. Convert the binary format to hexadecimal format. For the example, the hexadecimal sequence would be:

0000050050420000108404015000000

Computing the Checksum

The checksum is computed by adding together all of the non-zero bytes between the colon and the checksum of the Character Data Record. This sum is subtracted from the next larger multiple of 256. The result is entered as the checksum data byte before the sequence is transmitted to the printer. The checksum for the character in Figure 5 would be:

HEX	Decimal	
10	16	
04	4	
B0	176	
50	80	
05	5	512
04	4	- 475
20	32	<hr/>
01	1	37 Decimal
08	8	25 HEX
40	64	
40	64	
+15	+21	
1DB	475	

The same operation is performed by the printer after the data is received. The result is compared to the transmitted checksum to ensure data accuracy.

Composing the Character Data Record

After converting the matrix into character data and computing the checksum, you are ready to assemble the Character Data Record. The first character is a colon; followed by a 1 and a 0 for the byte count. Next, there are four characters for the two address bytes, and then two 0's for the record type. Then come 32 characters for the 16 data bytes, and two characters for the checksum. Then optional comments may be inserted before the mandatory Carriage Return (CR). A Line Feed may follow the CR, as may other comments.

Do not include any additional colons.

To load the character into the memory location for the upper-case letter K, the Data Record would be:

:1004B0000000005005042000010840401500000025

Proportional Spacing

This command you to improve the appearance and readability of text output. When this function is activated the print space of each character is adjusted according to the width of the character. The sequences for controlling Proportional Spacing are:

Begin Proportional Spacing

ESC	[<	6	h
1B	5B	3C	36	68

End Proportional Spacing

ESC	[<	6	l
1B	5B	3C	36	6C

l = Lower-case L

Characters Per Inch

The following escape sequence selects the characters per inch (CPI):

ESC	[n	w
1B	5B	n	77

where:

n = a value from Table 6 below.

Table 6 CPI Selections

CPI	ASCII	HEX
5 CPI	9	39
6 CPI	10	3130
6.67 CPI	11	3131
7.5 CPI	12	3132
8.33 CPI	13	3133
8.37 CPI	15	3135
10 CPI	4	34
12 CPI	5	35
13.33 CPI	8	38
15 CPI	1	31
16.67 CPI	6	36
17.14 CPI	17	3137
20 CPI	7	37

The CPI value may be changed at any time. However, selecting a new CPI value cancels a previous horizontal size selection (see the next escape sequence), and selecting a new horizontal size cancels the previous CPI value.

Character Height and CPI

This sequence allows you more control over how characters will look when they are printed out on the printer. With this command you can change both the character height and the character width, allowing you to print in wide characters for increased readability. To change character size, use the following escape sequence:

ESC	[n ₁	;	n ₂	Sp	B
1B	5B	n ₁	3B	n ₂	20	42

where:

n₁ = one of the values from Table 7.

Table 7 Character Height Multipliers

n1 values			Char. Height Amount of Increase
ASCII	HEX		
100	313030	=	normal height (10 CPI)
200	323030	=	twice normal height
300	333030	=	three times normal height
400	343030	=	four times normal height
500	353030	=	five times normal height
600	363030	=	six times normal height
700	373030	=	seven times normal height
800	383030	=	eight times normal height
900	393030	=	nine times normal height
1000	31303030	=	ten times normal height

NOTE: Changing the height of a character set will change the distance the paper moves in response to a Line Feed Command.

where:

n_2 = one of the values from Table 8.

Table 8 Character Width Multipliers

Range of n_2 values	CPI Selections
0	Default (10 CPI)
1-54	20
55-59	17.14
60-63	14.67
64-70	15
71-79	13.33
80-91	12
92-109	10
110-118	8.57
119-126	8.33
127-141	7.5
142-159	6.67
160-182	6
183-200	5

Table 8 lists all of the available CPIs on this emulation and the values used to select them. This command will work with any alphanumeric font.

A new CPI selection will cancel the horizontal size selected with this command, and selecting a new horizontal size cancels the previous CPI selection.

Page Formatting

Many of the parameters for formatting the print and page characteristics (such as LPI, Horizontal Tabs, etc.) can be set from your host computer using escape sequences. This section discusses and explains the Escape Sequences and Reserved Control Codes used for page formatting.

Line Per Inch

The following escape sequence selects lines per inch (LPI):

ESC	/	n	z
1B	5B	n	7A

where:

n = one of the values from Table 9 below.

Table 9 LPI Selections

LPI Selection	n Value	
	ASCII	HEX
1.5 LPI	7	37
2 LPI	8	38
3 LPI	9	39
4 LPI	10	3130
5 LPI	11	3131
6 LPI*	3	33
8 LPI	4	34
9 LPI	13	3133
10 LPI	6	36
12 LPI	15	3135

The LPI may be changed anywhere on a form. The current LPI setting is used to compute the physical form length when loading a **VFU** or selecting a form length. Changing the LPI does not change the physical form length, bottom- of-form skip, vertical tab stops, or **VFU** channel positions. However, it does change the size of the units by which they are set and reported. For example, an 11 inch form at 6 LPI has 66 lines, but the same form length has 88 lines at 8 LPI.

Variable Line Spacing

You may set up these emulations to use variable line spacing in increments of n/720 inch. To set up variable line spacing, use the sequence:

ESC	[<	n	Sp	h
1B	5B	3C	n	20	68

NOTE: A space is required before h. where:

n = desired line spacing in increments of n/720 inch.

Horizontal Tabs

The Tally ANSI sets default tabs at every eighth column. The following commands allow the user to manipulate Horizontal Tabs according to job requirements.

Setting Tabs

To set up to 16 horizontal tabs, use the sequence:

ESC	[n ₁	;	n ₂	;	n ₃	;	...n ₁₆	u
1B	5B	n ₁	3B	n ₂	3B	n ₃	3B	...n ₁₆	75

where n₁-n₁₆ = the column assigned as tab stop locations (up to 16 may be specified).

Example:

To set horizontal tabs at columns 15, 30, and 45, use the sequence:

ESC	[15	;	30	;	45	u
1B	5B	3135	3B	3330	3B	3435	75

Current Position

Horizontal tabs may also be set at the current position while sending a line of print data. To set a horizontal tab at the current position, use the sequence:

ESC	H
1B	48

Clearing Tabs

To clear tab stops at specific columns, use the sequence:

ESC	[n ₁	;	n ₂	;	n ₃	;	...n ₁₆	q
1B	5B	n ₁	3B	n ₂	3B	n ₃	3B	...n ₁₆	71

where n₁-n₁₆ = previously selected tab stop that will be removed.

Clearing All Horizontal Tabs

To clear all horizontal tabs (including the default tab settings), use the sequence:

ESC	[3	g
1B	5B	33	67

Clearing Current Horizontal Tab

To clear a horizontal tab at the current position, use the sequence:

ESC	[0	g
1B	5B	30	67

Setting Left and Right Margins

This escape sequence allows the user to set the left and right margins from the host. However, instead of using column numbers, which change when the CPI setting is changed, this command sets absolute margins in increments of 1/120 of an inch that do not change location when the CPI selection is changed.

The basic margin setting sequence is:

ESC	[LM	;	RM	"	s
1B	5B	LM	3B	RM	22	73

Each margin setting is calculated from the first dot position on the page. For example, if you want the left margin set 1 inch from the first dot position and the right margin set at 8 inches from the first dot position, multiply 120 x the desired inch setting and enter that amount in the proper location in the escape sequence.

To finish this example, you would finally enter margin values of 120/120 and 960/120, which would give you the escape sequence:

ESC	[120	;	960	"	s
1B	5B	313230	3B	393630	22	73

Setting Vertical Format

The top of the first line of print on a page is called the top-of-form (TOF) position. Vertical position is measured from this point. The form length is the distance from one TOF to the next. The bottom-of-form (BOF) skip is the distance between the last line of print on the page and the next TOF. Once the TOF and form length have been set, the paper will automatically advance to the next TOF whenever the print position advances into the BOF skip area. Vertical formatting includes the following settings:

- Physical length of the total form.
- Position of the first printed line on a form (TOF).
- Position of bottom-of-form and/or bottom-of-form skip.
- Position of any other vertical stops on a form.

There are three ways to set vertical format. One way involves using the menus on the printer to set the desired parameter values through the control panel. The other ways involve sending escape sequences or control codes from the host computer.

Form Length Select

The form length can be selected through the control panel or by sending the Form Length Select (FLS) escape sequence from the host. The basic FLS escape sequence is:

ESC	[n	t
1B	5B	n	74

where:

n = Form Length

If n = :

0, form length is 11 inches.

1, form length is 12 inches.

2-255, form length is equal to the value of n (in lines).

The FLS Command resets the current paper position as the TOF. Make sure the paper is aligned at the desired top-of-form before sending the FLS Command.

To calculate form length, multiply the form length in inches by the lines per inch. For instance, a 15.5" form printed at 6 LPI has a form length of 93 lines:

15.5" Form Length x 6 LPI = 93 (Total lines on form)

To set the form length for a 15.5" form, send the sequence:

ESC	[93	t
1B	5B	3933	74

Even though the form length can be set in number of lines, the printer divides the Form Length in lines by the LPI setting and stores the form length in inches, not number of lines. Subsequent changes in LPI will not change the physical form length.

Vertical Format Unit (VFU) Commands

The VFU Load not only sets values for the form length and bottom-of-form skip (see also, Skp Whn in the Operator's Manual), but also sets up vertical tabs on the page that are used by VFU Channel Commands. Load the printer VFU memory from your computer and then use VFU Channel Commands to move the paper to specific locations. Your printer uses electronic memory for its VFU, allowing the page format to be defined by commands from your computer up to a maximum storage of 255 lines.

Form lengths and vertical tab positions stored in the VFU memory are based on the Lines Per Inch (LPI) setting in effect at the time the VFU is loaded. Settings are not affected by changes in LPI or by entering Plot Mode.

VFU Load

To load the VFU, two escape sequences are needed, one to begin and one to end the load.

The VFU Load Command resets the current paper position as the top-of-form. Make sure the paper is aligned at the desired top-of-form before sending the VFU Load Command.

To begin a VFU download, use the sequence:

ESC	[<	1	h
1B	5B	3C	31	68

To end a VFU download, use the sequence:

ESC	[<	1	l
1B	5B	3C	31	6C

l = lowercase L

After the Begin-load escape sequence, all data, except ASCII control codes, is treated as VFU formatting information and is placed in VFU memory. All ASCII control codes and Escape sequences are ignored except the End-load sequence.

VFU Load Errors

All data must be in the proper VFU Load format. If an error occurs during the load or a load overruns memory length, the load is canceled and any remaining VFU data is printed. Canceled loads default to the current form length setting (as set from the control panel or with the FLS Escape Sequence).

To use the Vertical Format Units you download you must send a Vertical Channel Command, discussed below.

VFU Data Format

Bit:	7	6	5	4	3	2	1	0	
Value:	x	1	C6	C5	C4	C3	C2	C1	Byte 1
	x	1	C12	C11	C10	C9	C8	C7	Byte 2

where:

Bit 7 (x) = Not used.

Bit 6 = Always 1.

Bits 0–5 = VFU channels (C1–C12 = channels 1–12).

1 = channel present

0 = no channel

The byte-pairs for a sample load are shown in Table 10. The form length used for this example is 16 lines long; therefore, 16 byte-pairs are needed.

Table 10 Sample VFU Download

Byte #	Line #	Binary Value	Hex Value	Channel or Function	Byte #	Line #	Binary Value	Hex Value	Channel or Function
ESC[<1h				Start Code					
1	1	x1000001	41	1	17	9	x1000000	40	
2		x1000000	40		18		x1000000	40	
3	2	x1000000	40		19	10	x1000000	40	
4		x1000000	40		20		x1000000	40	
5	3	x1000000	40		21	11	x1100100	64	6 and 3
6		x1000000	40		22		x1000000	40	
7	4	x1000000	40		23	12	x1000000	40	
8		x1000000	40		24		x1000000	40	
9	5	x1000000	40		25	13	x1000000	40	
10		x1000000	40		26		x1000000	40	
11	6	x1000000	40		27	14	x1000000	40	
12		x1000000	40		28		x1000000	40	
13	7	x1000000	42	2	29	15	x1000000	40	
14		x1000000	40		30		x1100000	60	12
15	8	x1000000	40		31	16	x1001000	48	4
16		x1000000	40		32		x1000010	42	8
					ESC[<1				Stop Code

Paper And Print Position Movement

There are varieties of commands and escape sequences used to select paper and print movement functions. This section shows both the reserved commands and escape sequences.

When entering or exiting the Character or Plot modes, any data in the print buffer is printed. In Character Mode, the print position moves to the left margin of the current line, or to the current dot row in Plot Mode. If no paper motion command is issued, printing continues at the current print position. The following commands affect print position by moving the paper vertically or print position horizontally or both.

Reserved Control Codes

Horizontal Tab HT 09

This control code moves the print position to the next horizontal tab stop on a line. For multiple tabs, string multiple HT Control Codes together. The printer ignores HT Control Codes if horizontal tabs are not set or if the command is placed in a line beyond the available tabs.

By default, the printer sets a tab stop every 8 columns. These default tab stops can be altered or cleared using the Horizontal Tab Escape Sequence, listed earlier in this chapter.

In the Tally ANSI Emulation, horizontal tab stops change physical location with a change of the left margin or CPI. For example, if a stop is set at column 16, it will always be 15 columns from the left margin, but the physical distance will change for all CPIs.

Form Feed FF 0C

The FF Control Code advances the paper to the first print position of the next form. When Print on Paper Command (POPC) is set to ON, the FF Control Code initiates printing of the preceding buffer contents, then the paper moves to the next TOF.

Vertical Tab VT 0B

When the VFU is enabled, the VT Control Code is used to advance the paper to the next VT Channel location whether the printer is in Character Mode or Plot Mode.

The VT Channel is selected through the printer control panel. If the VFU is not enabled, a VT Command causes a single line feed. If POPC is enabled, the preceding buffer contents are printed before the VT Command is performed.

Carriage Return CR 0D

The Carriage Return (CR) Control Code moves the print position back to the left margin. It can be used to overstrike previously printed characters, to print from more than one character set, or to print more than one character size on a single line.

You can overstrike any character to create a special character or symbol, or you can overstrike to create bolder print, underline, etc.

Overstrike is possible only if Auto Line Feed is disabled.

In Automatic Line Feed Mode (Auto LF), when the printer encounters a CR Command, any printable data previously received is printed and the current print position (cursor) moves to the first column of the next line.

Line Feed LF 0A

The Line Feed (LF) Control Code advances the paper one line in Character Mode or one dot-row in Plot Mode.

If the Auto Carriage Return Parameter is set to ON, the printer also moves the print position to the left margin when it receives a Line Feed Command.

If Print on Paper Command (POPC) is enabled, any character data previously received is printed before the move.

- **Character Mode**

When a LF Command is issued in Character Mode, the actual distance the paper moves in response to a single LF Command depends on the LPI or the Variable Line Spacing setting.

- **Plot Mode**

When a LF Command is issued in Plot Mode, the actual distance the paper moves depends on the plot density setting for vertical DPI. For example, with a density of 100 dots per inch the paper would advance 1/100 inch, and with a density of 50 dots per inch the paper would advance 1/50 inch.

Save Print Position

The Save Print Position (SPP) Command saves the current print position into the printer's memory. The SPP escape sequence is:

ESC	P	B
1B	50	42

Restore Vertical Print Position

The Restore Vertical Print Position Command moves the paper to the last saved vertical cursor position. If no vertical cursor position has been saved on the current form, the paper moves to the current top-of-form. In either case, the active print position is moved to the left margin. The escape sequence is:

ESC	P	A
1B	50	41

Relative Paper Motion

The Relative Paper Motion (RPM) Command moves the paper forward or backward a requested number of increments from its current print position. Movement distance is dictated by the print mode (Character or Plot). The POPC Parameter dictates whether previous buffer contents are printed when the RPM Command is encountered.

Exceptions:

- Reverse paper motion stops at the Top-Of-Form (TOF) location on the current form.
- Forward motion into a Bottom-Of-Form (BOF) skip area advances the paper to the next TOF, then forward motion continues the remaining number of increments.

The relative paper motion escape sequence is:

ESC	[c	n	n	!	v
1B	5B	c	n	n	21	76

where:

c = Paper movement direction.

0 = forward paper motion

9 = reverse paper motion

nn = Number of increments the paper moves.

Range = 1 to 99 ASCII or 31 to 3939 HEX.

Example 1: Moving the paper forward five lines.

ESC	[0	0	5	!	v
1B	5B	30	30	35	21	76

Example 2: Moving the paper backward 13 lines.

ESC	[9	1	3	!	v
1B	5B	39	31	33	21	76

Reverse Form Feed

The Reverse Form Feed Command moves the paper backward to the top-of- form (TOF) position of the current form. If the paper is already positioned at the TOF when this command is received, no movement will occur. The Reverse Form Feed escape sequences:

ESC	[f
1B	5B	66

Forward Index

The Forward Index Command moves the paper forward one line with no change in horizontal position. This command is valid only in Character Mode; it is not allowed in Plot Mode. The Forward Index escape sequence is:

ESC	D
1B	44

Example:

Input: AESCDBESCDCESCDDCRLF

Output:

```

A
  B
    C
      D
  
```

After the CRLF, the print position would be on this line at the left margin.

Reverse Index

The Reverse Index Command moves the paper backward one line with no change in horizontal position. This command will not move the print location past the top of the current form and is valid only in Character Mode. The Reverse Index escape sequence is:

ESC	M
1B	4D

Example:

Input: A ESC M B ESC M C ESC M D C R L F L F L F L F

Output:

```
      D
     C
    B
   A
```

After the final LF, the print position would be on this line at the left margin.

Partial Line Advance

The Partial Line Advance Command moves the paper up or down a partial line for use in superscripting and subscripting. A parameter of 0 moves the paper up; 1 moves the paper down.

ESC	[n	Sp	p
1B	5B	n	20	70

VFU Channel Commands

After the VFU Memory is loaded, the format is set. To use the VFU Format, you must select VFU Mode on the printer. After selecting VFU Mode, you can send VFU Channel Commands to move the paper either forward or backward to the desired location. All reverse moves stop at the TOF if the requested channel is not found. The escape sequence for moving the paper to a desired channel is:

ESC	[c	nn	!	p
1B	5B	c	nn	21	70

where:

c = Paper motion direction.

0 = forward paper motion. 9 = reverse paper motion.

nn = VFU channel to which the paper will move. The value for each channel is shown in Table 11:

Table 11 VFU Channel Values

Channel	ASCII	HEX
1	00	3030
2	01	3031
3	02	3032
4	03	3033
5	04	3034
6	05	3035
7	06	3036
8	07	3037
9	08	3038
10	09	3039
11	10	3130
12	11	3131

The following examples give the format for forward and backward moves.

Example 1:

To move the paper forward (c = 0) to channel 4 (nn = 03), the escape sequence is:

ESC	[0	0	3	!	p
1B	5B	30	30	33	21	70

Example2:

To move the paper backward (c = 9) to channel 1 (nn = 00), the escape sequence is:

ESC	[9	0	0	!	p
1B	5B	39	30	30	21	70

Plot Mode

When Plot Mode is selected, all input data is treated as plotting data. All graphics in Plot Mode are designed and printed one dot-row at a time.

In Plot Mode the data stream dictates each dot to be printed. Data bytes are either bit images of the dots to be printed, or they are commands to repeat the previous bit image one or more times. Both the density of dots in the horizontal row, and the density of rows can be varied.

When switching from Character Printing to Plot Mode and vice versa, any data in the print buffer is printed. After the data prints out in Character Mode, the print position moves to the left margin of the current line. In Plot Mode it stays at the current dot row. If no paper motion command is issued, printing continues at the current print position.

When the printer enters Plot Mode, it starts plotting at the left margin, at the top row of the character dot matrix. When the printer exits Plot Mode, the position of the next print location depends on the setting of the ModPlot Parameter.

Plot Mode Commands

In Plot Mode, all control codes and escape sequences may be used. All of the commands work the same except the following:

- Line Feeds advance by the dot-row instead of line distances.
- Horizontal Tabs are not recognized.
- Forward Index commands are not recognized.
- Reverse Index commands are not recognized.

Entering Plot Mode

To enter Plot Mode, use the escape sequence:

ESC	[<	3	h
1B	5B	3C	33	68

Exiting Plot Mode

To exit Plot Mode and enter Character Mode, use the escape sequence:

ESC	[<	3	l
1B	5B	3C	33	6C

l = lowercase L

When the Modplot Parameter is set to ON, the printer automatically performs an Align to Line Boundary function and moves the print position to the next line down instead of the next dot row down. The default for this parameter is ON. The examples that follow show the actual results of both Modplot ON and Modplot OFF in Tally ANSI Emulation.

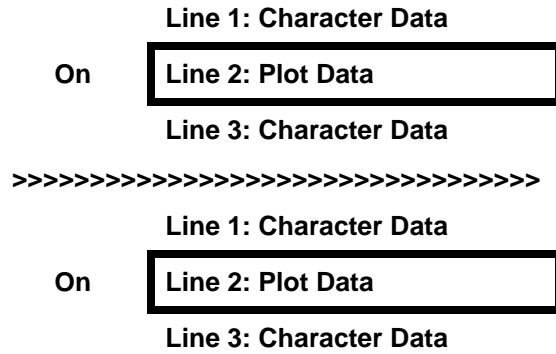

Figure 4 Alignment Using ModPlot

Align to Line Boundary

When you are exiting from the Plot Mode and the ModPlot Parameter is OFF it is necessary to send an Align to Line Boundary Command to advance the paper to the next line down (as measured from the current TOF). Without this command, characters and graphics would touch. The escape sequence is:

ESC	P	@
1B	50	40

Plot Data

Two types of information are needed for plot data. The first is an ASCII character (or numerical equivalent in whatever base number system your host requires; octal, decimal, hexadecimal, etc.) that designates which dot pattern you want to print. The second is a one or two byte numeric equivalent (oct., dec., or hex.) of the number of repetitions of the dot pattern you require. This information is converted into the following binary equivalents by the host for transmission to the printer.

Table 12 Plot Data Format

Plot Data	Bits							
	7	6	5	4	3	2	1	0
Dot Pattern Code	x	1	d	d	d	d	d	d
Repeat 1 - 15 Times	x	0	1	0	m	m	m	m
Repeat 16 - 240 Times	x	0	1	1	n	n	n	n

where:

x = Not used for Plot Data.

dddddd = Binary representation of the desired dot pattern.

0 = no dot

1 = dot

mmmm = Binary equivalent of 1–15 repetitions.

nxxx = Binary equivalent of 16–240 repetitions in multiples of 16.

A sample Dot Pattern Code is shown below. Six bits represent the dot pattern.

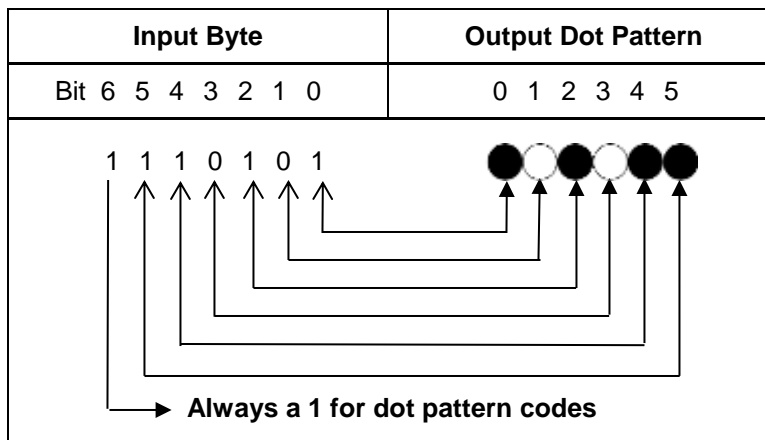

The clear arrows indicate dot-to-bit translation.

The solid black arrows indicate bit-to-dot output.

Figure 5 Sample Dot Pattern Code

Plot data is received as binary code that represents the dot pattern to be printed, as shown in Figure 5 above. If you do not have a table of the various dot patterns possible with their decimal and hexadecimal equivalents, you can use the following method to compute the numeric equivalents.

First, plot out the dot pattern, then convert the six dot pattern to a six-bit binary number (0 for no dot and 1 for a dot). For example:

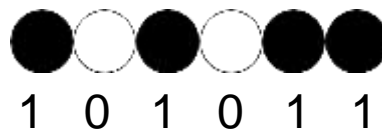

Figure 6 Sample Bit Pattern

Now reverse the order of the binary digits. The leftmost dot position (most significant bit) becomes the least significant bit and so on.

$$101011 \Rightarrow 110101$$

Convert the new binary number, 110101, to whatever number system you use (octal, decimal, hexadecimal, etc.) to send the code to the printer. The host computer then retranslates the numbers you use back to their binary equivalents for transmission to the printer.

Plotting Dot Patterns

To construct the data code for a specific dot pattern and have the printer print that dot pattern, refer to Table 13 below and perform the procedure that follows.

Table 13 Dot Patterns and Identifiers

Dot Pattern	CODE			Dot Pattern	CODE		
	ASCII	HEX	DEC		ASCII	HEX	DEC
	@	40	64		'	60	96
	A	41	65		g	61	97
	D	42	66		b	62	98
	c	43	67		d	63	99
	D	44	68		d	64	100
	E	45	69		e	65	101
	F	46	70		f	66	102
	G	47	71		g	67	103
	H	48	72		h	68	104
	I	49	73		i	69	105
	J	4A	74		j	6A	106
	K	4B	75		k	6B	107
	L	4C	76		l	6C	108
	M	4D	77		m	6D	109
	N	4E	78		n	6E	110
	O	4F	79		o	6F	111
	P	50	80		p	70	112
	Q	51	81		q	71	113
	R	52	82		r	72	114

Table 13 Dot Patterns and Identifiers

Dot Pattern	CODE			Dot Pattern	CODE		
	ASCII	HEX	DEC		ASCII	HEX	DEC
●●○○●○	S	53	83	●●○○●●	s	73	115
○○●○●○	T	54	84	○○●○●●	t	74	116
●○○●○○	U	55	85	●○●○●●	u	75	117
○●●○○○	V	56	86	○●●○●●	v	76	118
●●●○○○	W	57	87	●●●○●●	w	77	119
○○○○●●	X	58	88	○○○○●●	x	78	120
●○○●●○	Y	59	89	●○○●●●	y	79	121
○●○●●○	Z	5A	90	○●○●●●	z	7A	122
●●○○●●	[5B	91	●●○○●●	{	7B	123
○○●●●○	\	5C	92	○○●●●●		7C	124
●○○●●○]	5D	93	●○○●●●	}	7D	125
○●●●●○	^	5E	94	○●●●●●	~	7E	126
●●●●●○	-	5F	95	●●●●●●	DEL	7F	127

1. Find the desired dot pattern from the two dot pattern columns.
2. Look to the right of the dot pattern and determine the number for this particular dot pattern. Table 13 provides the ASCII, Hexadecimal, and Decimal equivalent. Whatever code you use, this number becomes the dot-pattern designator.

3. Send the Enter Plot Mode escape sequence followed by the dot-pattern designator (ASCII = u), like this:

ESC	[<	3	h	u
1B	5B	3C	33	68	75

The desired dot pattern will print one time.

Repeating a Pattern

To repeat a dot pattern, add the desired number of repetitions after the dot-pattern designator. When no repetitions are designated, the printer defaults to 1 and the dot pattern will be printed 1 time. For repetitions of 15 or fewer, the ASCII codes used to designate the number of repetitions begin with Sp (0) and continue through to the / (15).

In the example that follows Table 14, we show the sequence of actions required to compose an ASCII data code.

Table 14 Repetition Conversion Table

Repetitions 1–15	ASCII Value	Multiples of 16	ASCII Value
0	Sp	00	0
1	!	16 x 1 = 16	1
2	“	16 x 2 = 32	2
3	#	16 x 3 = 48	3
4	\$	16 x 4 = 64	4
5	%	16 x 5 = 80	5
6	&	16 x 6 = 96	6
7	‘	16 x 7 = 112	7
8	(16 x 8 = 128	8
9)	16 x 9 = 144	9
10	*	16 x 10 = 160	:
11	+	16 x 11 = 176	;
12	,	16 x 12 = 192	<
13	–	16 x 13 = 208	=
14	.	16 x 14 = 224	>
15	/	16 x 15 = 240	?

For example, if you wanted to print a pattern 10 times you would look up 10 in the repetition column above; the ASCII character that corresponds to 10 is an asterisk (*). Therefore, placing an asterisk after a dot-pattern designator would cause the printer to repeat the pattern 10 times.

For numbers greater than 15, you must send a two-byte code:

- Byte 1 = (the remainder of the number of desired repetitions) ÷ 16
 - Byte 2 = (number of desired repetitions)
- (largest possible multiple of 16 that will result in a positive integer or 0)

The maximum number of times a dot pattern may be repeated per request is 255. The ASCII characters that are used to represent multiples of 16 are 0–? (HEX 30–3F).

Example:

To send 70 repetitions, you must first find the largest multiple of 16 that is less than or equal to 70, then subtract that number from 70 to find the remainder. From the above table you can see that the largest multiple of 16 that is less than or equal to 70 is 64. Subtracting 64 from 70 gives us a result of 6. To find the ASCII equivalent of 6, use Table 13. To compile the 2-byte code for 70 repetitions, remember, the remainder comes first. The result will be & for the remainder of 6, followed by 4 for the multiple of 16 (64).

ESC	[<	3	h	u	&	4
1B	5B	3C	33	68	75	26	34

Stringing Commands Together

Different dot-pattern designators may be strung together in a single escape sequence to enable printing special graphics. To illustrate stringing designators together, we will use a single dot-pattern command repeated eight times and string together 6 of these commands. That escape sequence is:

ESC[<3h	A	(A	(A	(A	(A	(A	(CRLF
1B	41	28	41	28	41	28	41	28	41	28	41	28	0D0A

Where:

A = The dot pattern. 

(= 8 repetitions of the dot pattern. (See Table 13 on page 35).

This would result in the selected dot pattern being printed 48 times across the page. Or you may send just a single command that specifies that the selected dot pattern is to be printed 48 times:

ESC	[<	3	h	A	SP	3	CR	LF
1B	5B	3C	33	68	41	20	33	0D	0A

The second escape sequence format is more economical and easier to use when stringing commands together, but either of the above commands would result in a horizontal line of 48 dots across the page.

Repeating either of the above command/CRLF sequences would cause printing of vertical bars across the page. For example, repeating either of the above sequences 100 times would result in:



The advantage of being able to string commands together is that it enables you to put commands for different dot patterns together in one escape sequence for designing special graphics to be printed on your printer. In the next example, the plot density has been set to 60 DPI by 60 DPI to show the dot pattern clearly. Sending the following escape sequence 20 times,

```
ESC[ <3hA$1CRLF B$1CRLF D$1CRLF F$1CRLF P$1CRLF ` $1CRLF
```

will result in the following graphic:



Plot Density

In Plot Mode, your printer will print in a variety of dot densities, both horizontally and vertically. The default density in Plot Mode is 100 dots per inch (DPI) in both the horizontal and vertical directions. To select a different density, use the escape sequence:

ESC	[n ₁	;	n ₂	!	q
1B	5B	n ₁	3B	n ₂	21	71

where:

n₁ = Horizontal density in DPI. Valid values are 40, 48, 50, 72, 75, 80, 90, 96, 100, 120, 144, 150, 160, 180, 200, and 240.

n₂ = Vertical density in DPI. Any value from 40 to 288 is allowed.

When you change the plot densities, they remain active until the printer is turned off or they are changed again.

To determine the number of dot patterns necessary to print a full line, multiply the line length by the horizontal DPI, then divide the total by 6 (each dot pattern = 6 bits).

Example:

If line length = 13.2" and DPI = 100, then

Total dots per line = 13.2 x 100=1320, and

Total dot patterns per line = 1320/6 = 220

Therefore, to print a full 13.2 inch line at 100 DPI you would have to send 220 dot patterns.

Shading effects can be created by printing different dot patterns in subsequent rows.

Miscellaneous Functions**Reset Printer to Powerup Settings**

You can reset the printer to all its powerup settings by sending the escape sequence:

ESC	/	6	~
1B	5B	36	7E

~ = tilde

Custom Message Display

You can create and send a message of up to 16 characters to the control panel display with the sequence:

ESC	P	F	mess	ESC	\
1B	50	46	mess	1B	5C

where:

mess = The message to be displayed (up to 16 characters).

Any ASCII characters may be used for your custom display, but to avoid confusion, your message should be different from any of the standard messages. The message remains on the control panel display until the next operator action or an error occurs.

Example:

If the printer needs to be loaded with a different size of paper before printing correspondence, alert the operator to change paper by sending a Bell Command and issuing the Custom Display Command immediately before the letter data. To display the message Change Paper on the control panel, the escape sequence would be:

ESC PF	C	h	a	n	g	e	SP	P	a	p	e	r	ESC\
1B5046	43	68	61	6E	67	65	20	50	61	70	65	72	1B5C

Save Current Configuration

This escape sequence allows you to save the Current Configuration to the Powerup Configuration from the host computer.

ESC	P	C
1B	50	43

Alternate Escape Sequences

Since some systems will not allow ESC (1B hex) to be sent as the escape function, you can substitute the following codes:

^	CR
5E	0D

OR

^	CR	LF
5E	0D	0A

But they must be placed in Column 1 (the left margin), and Alt ESC must be set to ENABLED through the control panel (see the Codes Category of the Configuration Menu).

POSTNET Bar Codes

POSTNET Bar Code Mode allows you to make use of the mail handling systems that the United States Postal Service (USPS) has implemented. In addition, POSTNET Bar Codes allow you to take advantage of postal discounts available through USPS for mail pieces using POSTNET Bar Codes for regular 5 digit, Zip+4, and Advanced Bar Code (ABC) zip codes. The basic sequence is:

ESC	P	b	data
1B	50	62	data

After entering POSTNET Mode, any ASCII characters can be sent. However, only the characters 0–9 will be printed. All others, except the reserved control codes and the Space character (Hex 20) are ignored. All reserved control codes, except the ESC (HEX 1B) and the HT (HEX 09) control codes, cancel POSTNET Mode. After POSTNET Mode is canceled, the printer will perform the requested function, such as Line Feed or Form Feed.

The Space character can be used to space between bar codes. If placed inside a bar code, it will terminate the current bar code and cause the framing bar to print. Then the cursor will move the equivalent of one space. Additional spaces can be sent and the cursor position will move the requested number of spaces, then another bar code can be printed. Use the Space character between bar codes only.

The ESC Control Code is used in some applications to select different parameters while in POSTNET Mode.

The HT Control Code is used while in POSTNET Mode to control horizontal space between bar codes. To use the HT Control Code, the procedure is:

If you are NOT going to use the Default Tabs, begin here:

1. Clear all current Horizontal Tab settings.
2. Set desired Horizontal Tabs.

If using the Default Tabs, begin here:

3. Enter POSTNET Mode.
4. Send data + HT....data + HT....
5. Exit POSTNET Mode.

Example:

ESC	P	b	9	9	9	9	9	HT	9	8	9	8	9	CR
1B	50	62	39	39	39	39	39	09	39	38	39	38	39	0D

The above sequence would cause bar codes representing the digits 99999 and 98989 to print on the same line, spaced at whatever distance the Horizontal Tabs designate, then the printer would exit the POSTNET Mode.

PLANET Bar Codes

PLANET is similar to POSTNET in "look and feel", and is intended to complement the use of POSTNET for mass mailers. For more information, see the PLANET Bar Code website, <http://www.planetcodes.com/>.

The escape sequence for printing PLANET bar codes is:

ESC	P	f	data
1B	50	62	data

The syntax is the same as POSTNET.

Emulation and Configuration Switching

In addition to being able to change emulations or configurations through the printer control panel, you can use this escape sequence to change emulations or configurations from your host computer.

Unlike changing emulations through the control panel, when this escape sequence is used to change emulations, it does not change the Powerup or Alternate configurations that are currently loaded on the printer. The only configuration that is affected is the Current Configuration. The basic switching sequence is:

ESC	[<	n	h
1B	5B	3C	n	68

where:

n = One of the selections from the list below.

10 = Powerup Emulation

11 = Default Emulation

13 = Epson Emulation

14 = Tally ANSI Emulation

15 = IBM Proprinter Emulation

16 = Genicom ANSI

17 = LG01 Emulation

18 = HP 2564C Emulation

19 = MTPL Emulation

20 = WinEmul

30 = Config 1

31 = Config 2

32 = Config 3

33 = Config 4

34 = Config 5

35 = Config 6

36 = Config 7

37 = Config 8

38 = Config 9

39 = Config 10

Reserved Control Codes

In this emulation there are different combinations of reserved control codes you may use to control various aspects of printer operations. In addition, there are reserved control codes that are used "behind the scenes" in communication between the host computer and the printer, and in data handling protocols.

Table 15 below lists the codes for the Tally ANSI Emulation. In addition, we show in which interface they are valid and give a basic explanation of their function.

Interface Key:

S = Serial

C = Centronics

In the Serial and Centronics interfaces, when an invalid control code is received, it is discarded.

Table 15 Tally ANSI Control Codes

ASCII	Interface	Function
ETX*	S	Signals the End of Text to the Printer.
ENQ*	S	Enquiry code sent by the computer to the printer.
ACK*	S	Sent by the printer to indicate that there were no errors in the data transmission.
BEL	S, C	Sounds printer alarm for .5 seconds.
HT	S, C	Moves the print position to the next horizontal tab stop.
LF	S, C	Advances paper one line for printing or one row for plotting.
VT	S, C	Advances paper to the next selected VFU Vertical Tab channel.
FF	S, C	Advances the paper to the top of the next form.
CR	S, C	Moves the print position to the left margin of the current line.
SO	S, C	Selects the alternate character set for printing.
SI	S, C	Selects the primary character set for printing.
DC1* (XON)	S, C	When the data buffer is ready to accept more data, XON allows new data to be sent from the host computer.
DC3* (XOFF)	S, C	XOFF stops data transmission from the host computer when the data buffer signals it is full.
NAK	S	Printer warns host that there was an error in the data transmission.
ESC	S, C	Tells the printer that the data that follows is not to be printed but is to be interpreted as a control function.
DEL	S, C	The Delete Control Code defaults to the Rubout character. It can be used to delete characters in the buffer if your printer is setup properly. Call your technical support for set up procedure.

Escape Sequence Summary

The following escape sequences are supported:

Table 16 Tally ANSI Escape Sequence Summary

Sequence	Function	Description
ESC D	Index Forward	Moves the paper forward one line with no change to the horizontal position.
ESC H	Set Tab	Sets a tab stop at the current horizontal position.
ESC M	Index Reverse	Moves the paper backward one line with no change to the horizontal position. Requires the RevPap control panel parameter to be set to ON.
ESC P@	Align to Line Boundary	Moves the vertical position to the next line relative to top of form as defined by the current LPI setting.
ESC PA	Restore Cursor Position	Moves the print position to the beginning of the saved vertical position. If a reverse paper movement is required, RevPap must be ON.
ESC PB	Save Cursor Position	Saves the current vertical position.
ESC PC	Save Powerup Configuration	Saves the current configuration into the Powerup Configuration.
ESC PD	Upload Configuration	Uploads the configuration and calibration reports to the host via the serial interface. Special for TUS Production.
ESC PF msg ESC \	Custom Display	Displays a message on the control panel display.
ESC PG	Config Report	Causes a config report to be printed. Special for TUS Production.
ESC PH	CalData Report	Causes a cal data report to be printed. Special for TUS Production.
ESC Pb	POSTNET Mode	Causes the following digits to be printed as POSTNET bar codes.
ESC Pc or ESC Pe	UK Post Mode	Causes the following digits to be printed as UK postal bar codes. Special for Tally UK.
ESC Pd	KIX Mode	Causes the following digits to be printed as Dutch KIX postal bar codes. Special for Tally UK.
ESC Pf	PLANET Mode	Causes the following digits to be printed as PLANET postal bar codes.
ESC, A ESC (xx	Select G0 Character Set	Selects the G0 character set.

Table 16 Tally ANSI Escape Sequence Summary

Sequence	Function	Description
ESC - A ESC) xx	Select G1 Character Set	Selects the G1 character set.
ESC [n z	Select LPI	Selects lines per inch.
ESC [n w	Select CPI	Selects characters per inch.
ESC [n m	Select Attributes	Selects bold, italics, overline, strikethrough, underline, subscript and superscript attributes. Also DP, Draft, Gothic, Courier, OCR-A and OCR-B font styles and downloaded font.
ESC [n t	Select From Length	Select form length. 2 to 255 lines, or 11 inches or 12 inches.
ESC [n u	Set Horizontal Tabs	Sets horizontal tab stops.
ESC [n q	Clear Horizontal Tabs	Clears horizontal tab stops.
ESC [3 g	Clear All Tabs	Clear all tab stops.
ESC [0 g	Clear Current Tab	Clear a tab stop at the current horizontal position.
ESC [6 ~	Reset	Resets to Powerup Configuration.
ESC [cn !p	VFU Channel Command	Performs a VFU channel move. If a reverse paper movement is required, RevPap must be ON.
ESC [cn !v	Relative paper Motion	Performs a relative paper move. If a reverse paper movement is required, RevPap must be ON.
ESC [n !s	Select Character Sets	Selects the primary (G0) and alternate (G1) fonts and character sets (languages).
ESC [n sp B	Select Character Size	Selects the character height and width.
ESC [n1;n2 !q	Select Plot Density	Selects the horizontal and vertical plot densities. Also selects shuttle speed and spacing (speed and spacing options are undocumented).
ESC [n "s	Set Margins	Sets the left and right margins in 1/120ths.
ESC [n sp p	Partial Line	Performs a partial (half) line advance up or down.
ESC [f	Reverse FF	Backs paper up to the previous TOF. RevPap must be ON.

Table 16 Tally ANSI Escape Sequence Summary

Sequence	Function	Description
ESC [< 1 h ESC [< 1 l	VFU Download	Begins and ends a VFU download.
ESC [< 2 h ESC [< 2 l	Font Download	Begins and ends a font download.
ESC [< 3 h ESC [< 3 l	Plot Mode	Begins and ends plot mode.
ESC [< 6 h ESC [< 6 l	Proportional Spacing	Begins and ends proportional spacing.
ESC [< n h	Emulation & Configuration Switching	Changes emulations when n = 10 - 39
ESC [< n sp h	Variable Line Spacing	Sets the line advance distance in 1/720ths.

Genicom ANSI

Emulation Definition

Control Code and Escape Sequence Activity Levels

ANSI control codes and escape sequences are assigned activity levels depending on which print mode is currently active. The following charts provide information on what to expect from the control codes and escape sequences in each printing mode.

- I-Ignored No noticeable effect on printing will occur.
- V-Valid These sequences do not affect the printing mode in progress, but take effect when normal printing resumes.
- A-Active This sequence takes effect immediately D-Data These control codes are used as data.

Note 1: When printer option 1 is active, either ANSI (4800) emulation, ANSI (4410) emulation, <SO>, or <SI> activates or deactivates this printing mode. <SO> and <SI> are valid in barcodes and oversize print mode. They are active in expanded print mode.

Note 2: Valid during enhanced oversize, Active during normal oversize.

Note 3: Discarded while in the native mode.

Note 4: Causes an error symbol to print (XOX).

Table 17 Control Code Activity Levels

Control Code	Line Terminator	Normal	Dot Graphics	Bar Codes	Oversize	POSTNET
BEL	No	A	A	D	A	Note 4
BS	Yes	A	I	I	I	Note 4
CR	Yes	A	A	I	A	Note 4
DC1	No	A	A	D	A	Note 4
DC3	No	A	A	D	A	Note 4
DEL	No	Note 3	Note 3	D	Note 3	Note 4
FF	Yes	A	A	I	A	Note 4
HT	No	A	A	A	A	A
LF	Yes	A	A	I	A	Note 4
SI	No	A	I	Note 1	Note 1	Note 4
SO	No	A	I	Note 1	Note 1	Note 4
VT	Yes	A	A	I	A	Note 4

Table 18 Escape Sequence Activity Levels

Escape Sequence	Line Terminator	Normal	Dot Graphics	Bar Codes	Oversize	POSTNET
DCS (Graphics)	No	A	I	I	A	I
Font Load	No	A	I	I	A	I
GENBCS	No	A	A	A	A	I
GENFD	No	A	A	A	A	I
GENGRM	No	A	V	A	A	I
GENHTS	No	A	A	A	A	I
GENOSM	No	A	V	V	A	I
GENSLR	No	A	A	A	A	I
GENSNC	No	A	V	V	Note 2	I
GENSPM	No	A	V	A	A	A
GENTST	Yes	A	A	I	A	I
GENVFU	Yes	A	A	A	A	I
DENVTS	No	A	A	A	A	I
GSM	No	A	V	V	A	I
HPA	Yes	A	A	A	A	I
HPB	Yes	A	A	A	A	I
HPR	No	A	A	A	A	I
HTS	No	A	A	A	A	I
HVP	Yes	A	A	A	A	I
PLD	Yes	A	I	I	A	I
PLU	Yes	A	I	I	A	I
REP	No	A	A	I	A	I
RIS	No	A	A	A	A	I
RM	No	A	A	A	A	I
SGR	No	A	V	V	Note 2	I
SM	No	A	A	A	A	I
SPI	No	A	V	V	Note 2	I
ST	No	I	A	I	I	I
TBC	No	A	A	A	A	I

Table 18 Escape Sequence Activity Levels

Escape Sequence	Line Terminator	Normal	Dot Graphics	Bar Codes	Oversize	POSTNET
VFU Load	No	A	I	I	A	I
VPA	Yes	A	A	A	A	I
VPB	Yes	A	A	A	A	I
VPR	Yes	A	A	A	A	I
VTS	No	A	A	A	A	I

Control Code Definitions

- BEL** Bell (07H): Receipt of a BEL code causes the beeper to sound for approximately 1/2 second after any preceding printable data has been processed.
- BS** Back Space (08H): Line terminator. The paper position remains unchanged and the print position is moved left one character space from the current. If the print position is at the left margin, no action is taken.
- CR** Carriage Return (0DH): Line terminator. The print position is reset to the left margin, and the paper position is left unchanged.
- CSI** Control Sequence Introducer (9BH): Signals the beginning of an ANSI control sequence. When 8-bit data is used, CSI (9BH) can be substituted for ESC [(1BH 5BH). Also see ESC.
- DC1** Device Control 1 (11H): Parallel and Serial Interface: Receipt of a DC1 code with the printer in local mode puts the printer online (selects printer) and enables receipt of data. Through CCU menu options, a serial interface protocol may be selected that transmits a DC1 code to the host to signal that the printer is ready to receive data.
- NOTE:** The print position can also be set to the left margin via the CCU Control Panel menu using SETUP/FORMAT/MODIFY FORMAT/ PRINT CONTROL menu selection.
- DC3** Device Control 3 (13H): Parallel and Serial Interface: Receipt of a DC3 code when online places the printer in local mode (deselects printer) and causes it to ignore all data except a <DC1>. Through menu options, a serial interface protocol may be selected that transmits a <DC3> code to the host signal that the printer is not ready to receive data. See note for DC1 on page 50.
- ESC** Escape (1BH): Signals the beginning of an escape sequence. Also see CSI on page 50.
- FF** Form Feed (OCH): Line terminator. The paper is advanced to the next top-of-form position. When EVFU is enabled and programmed, paper will advance to the next stop in channel 1.
- NOTE:** An option strap from the CCU Control Panel menu using the SETUP/ FORMAT/MODIFY FORMAT/GENPRTOPTS section can disable this feature.
- HT** Horizontal Tab (09H): Advances the print position to the next horizontal tab location. If no tabs are set, an HT code is either converted to a space or ignored, depending on the menu option settings.

- LF Line Feed (OAH): Line terminator. The paper is advanced to the next line. When printing horizontal dot graphics, the paper is advanced to the next dot row.
See note for FF above.
- SI Shift In (0FH): Used to exit a Special Print Mode (GENSPM) when ANSI emulation strap 1 is active.
- SO Shift Out (OEH): Used to enable a special print mode (GENSPM) when ANSI emulation strap is inactive.
- VT Vertical Tab (OBH): Line terminator. The paper is advanced to the next vertical tab stop. If no tabs are set, a VT code causes a line feed. When using the EVFU, paper advances to the next stop in channel 12.
See note for FF above.

Escape Sequence Directory

Sequence	Meaning
CSI or ESC [Control Sequence Introducer
CSI p1 p2 SP -	GENEMU: Selects emulation
ESC [p1; p2 SP B	GSM: Modifies vertical (p1) and horizontal (p2) character size.
ESC [p1; p2 SP G	SPI: Sets lpi (p1) and/or cpi (p2) in decipoints.
ESC H	HTS: Sets a tab at current print position.
ESC J	VTS: Sets a tab at current paper position.
ESC K	PLD: Moves print line down 3/72 inch (subscript).
ESC L	PLU: Moves print line up 3/72 inch (superscript).
ESC P	DCS: Introduces dot graphics.
ESC Q	Self-Test: Inactive. Sequence ignored.
ESC [p1 a	HPR: Moves print position right p1 distance (relative).
ESC [p1 b	REP: Dot graphics: repeat preceding character p1 times.
ESC c	RIS: Resets printer to a known initial state
ESC [p1 d	VPA: Sets vertical position to p1 decipoints or lines.
ESC [p1 e	VPR: Moves paper forward p1 decipoints.

Sequence	Meaning
ESC [p1; p2 f	HVP: Moves paper and print position (absolute).
ESC [p1 g	TBC: Clears tabs: P1 = 3 for horizontal.
ESC [p1 ; ...; pn h	SM: Set mode (PUM, LNM, proportional character mapping).
ESC [p1 j	HPB: Moves print position left by decipoints or columns.
ESC [p1 k	VPB: Moves paper backward by decipoints or lines.
ESC [p1 l	RM: Reset mode (PUM, LNM, proportional, character mapping).
ESC [p1; ... pn m	SGR: Selects font styles and enhancements.
ESC [p1 p2 ! p	GENVF2: EVFU vertical paper movement command.
ESC [p1 ; p2 ; p3 q	GENVF2: EVFU vertical paper movement command.
ESC [p2 ; p2 ; p3 r	GENFD: Sets form length (p1), margins: top (p2), bottom (p3).
ESC [p1; p2 s	GENSLR: Sets margins: (p1), right (p2) in decipoints.
ESC [p1 t	Selects bar codes p1=3, quit bar code p1=0.
ESC [p1;... pn u	GENHTS: Sets horizontal tabs (p1, etc.) in decipoints or columns.
ESC [p1 ;... p12;v	GENVTS: Sets vertical tabs (p1, etc.) in decipoints or lines.
ESC [p1 x	GENSNC: Selects international character sets.
ESC [p1 ; ...;p10}	Selects bar code parameters.
ESC [p1 SP}	GENDFC: Download Font Control: Checks printer for downloaded font.
OSC or ESC]	Operating System Command: introduces sequence.
ESC] 5	BFL (Begin Font Load): Valid only if download option is installed.
ESC]!	Begins 12-channel EVFU table loading.

Sequence	Meaning
ESC \	ST: String Terminator. Exits special modes.
ESC [p1	HPA: Horizontal Position Absolute
OSC 9 ; p1 ; ... ; p8-pn ST	Character Map Load

ANSI Escape Sequence Categories

The ANSI escape sequences have been separated according to functionality. Special areas of interest, such as graphics and the electronic vertical format unit (EVFU), have been described in separate sections. The functional groups are:

- Housekeeping
- Paper and Print Positioning
- Margins and Tabs
- Font Handling and Enhancements
- Graphics
- EVFU

Housekeeping Sequences

- ESC [CSI (Control Sequence Introducer): This sequence is used to begin sequences, that generally have multiple parameters.
- ESC] OSC (Operating System Command): This is another special sequence introducer. Sequences which begin with OSC require the ST string terminator sequence (ESC \) to end them.
- ESC \ ST (String Terminator): Terminates the loading of EVFU tables, download fonts, and dot graphics strings.
- ESC c RIS (Reset to Initial State): Resets the printer to either the standard state shown below or to the state stored in the customer save area of memory. The RIS sequence can be disabled by ANSI option strap 3.

RIS – Reset to Initial State	
Parameter	State
Font Style	Gothic Draft
Character Size	1X Vertical, 1X Horizontal
Character Pitch	10 cpi
Country Selection	USA
Code Page	437
Line Spacing	6 lpi
Partial Line Up	Reset
Partial Line Down	Reset
Bold Print	Inactive
Underline Mode	Inactive
Expanded Mode	Inactive
Proportional Mode	Reset
Horizontal Tab Table	Empty
Left Margin	None - Column O
Right Margin	None - Maximum
Form Number	7
Page Size	7920 decipoints/ 66 lines/ 11 inches
Top Margin	None
Bottom Margin	None
Forms Position	Top of form - current position
Vertical Tab Table	Empty
Vertical Format Unit	Default
Graphics Density	60 H dpi, 72 V dpi, horizontal format
VFU Load In progress	Exit (nothing saved)
Bar Code Mode	Inactive
Dot Graphics	Inactive

Decimal 27.99
 Hex 1B 63
 BASIC: CHR\$(27);“c”;
 ESC Q GENTST (Self-Test): This sequence is ignored.
 Decimal: 27 102 or 120
 Hex: 1B 5C or 9C
 Basic: CHR\$(27); “Q”;

CSI p1 p2 SP ~

GENEMU (Emulation Control): Switches the control of the printer to another emulation. The parameters in the sequence are defined as follows:

- p1 Emulation identifier. This parameter selects the particular emulation by a reference number supplied by GENICOM engineering. The assigned numbers may be found in the table below.
- p2 Reset control. Permits the parameters of the printer to be reset or defaulted. It is not always possible to meet the strict definition of this parameter, so each printer has a definition of how the reset control is implemented. The values as currently defined are:
 - 0 Hold values (default). All possible values for printer control, e.g., tabs, margins, page length, are to be retained.
 - 1 Full reset. Resets parameters to initial state.

p1	Manufacturer	Emulation
0	GENICOM	ANSI
10	GENICOM	4410 ANSI
1-19	GENICOM	Reserved
20	IBM	Graphics Printer
21	IBM	Proprinter XL 9-wire
22	Epson	FX286-e
23	IBM	Proprinter XL 24-wire
24	Epson	LQ2500
30	Data Products	ANSI
40	Printronix	P3000
41	Printronix	P5008

Indeterminate Conditions

If no emulation parameter is supplied, the emulation remains in the current state and the rest of the sequence is ignored. Other parameter values and other parameters are reserved.

Mnemonic: <CSI> <p1> <p2> <SP> ~

Decimal: 27 91 <p1> <p2> 32 126

Hex: 1B 5B <p1> <p2> 20 7E

BASIC: CHR\$(27);"<p1><p2><SP>~"

Character Set Selection

ESC [p1 x GENSNC (Select National Set): This sequence selects the national character substitution. The following values may be used for p1.

P1	Country Map or Character Map
0	USA (ISO)
1	German (ISO)
2	French A (ISO)
4	French Canadian
6	Italian
7	United Kingdom (ISO)
8	Spanish
9	Danish/Norwegian A
10	Danish/Norwegian B
11	Danish/Norwegian C
12	Danish/Norwegian D
13	Swedish/Finnish A
14	Swedish/Finnish B
15	Swedish/Finnish C
16	Swedish/Finnish D
20	United Kingdom A
23	Italian (ISO)
24	Spanish (ISO)
437	Code Page 437
850	Code Page 850 (Latin 1)
852	Code Page 852 (Latin 2)
855	Code Page 855 (Cyrillic)

P1	Country Map or Character Map
863	Code Page 863 (French Canadian)
866	Code Page 866 (Russian)
8573	Greek Code Page 437
8574	DEC Multinational (LA-210)
8575	Roman 8
8577	Turkish 8-bit Code Page
8578	Greek Code Page 851
8591	ISO 8859-1 Latin 1
8592	ISO 8859-2 Latin 2
8595	ISO 8859-5 Cyrillic
8597	ISO 8859-7 Greek
8598	ISO 8859-8 Hebrew
8599	ISO 8859-9 Latin 5

Paper and Print Position Movements

ESC K PLD (Partial Line Down): Line terminator. Moves the print line down 3/72 inch for subscript printing. Also returns to the original line following a partial line up (<ESC> L - superscript) sequence.

Decimal: 22 75

Hex: 1B 4B

BASIC: CHR\$(27);"K";

ESC L PLU (Partial Line Up): Line terminator. Moves the print line up 3/ 72 inch for superscript printing. Also used to return to the original line following a partial line down (ESC K - subscript) sequence.

Decimal: 22 76

Hex: 1B 4C

BASIC: CHR\$(27);"["<pl>a";

ESC [p1 d VPA (Vertical Position Absolute): Line terminator. Sets the vertical position to the value specified by <p1>, moving paper forward or backward to the new position. The distance specified by the <p1> parameter is in decipoints. This command can be used to print inside top and bottom margins. If the specified position is not within the current page, the command is ignored. If the parameter value is omitted or less than 5 decipoints, it will result in the vertical position being set to the top for form position.

Decimal: 27 91 <p1> 100

Hex: 1B 5B <p1> 64

BASIC: CHR\$(27);"[";CHR\$(<p1>);"d";

ESC [p1 e VPR (Vertical Position Relative): Line terminator. Increases the current vertical position by the value specified by p1. Decipoints are converted to provide the 1/144-inch moves show in the table below.

Decipoint Value	Movement In Inches
Missing or 0 - 4	No Movement
5 - 9	1/144 inch
10 - 14	2/144 inch
15 - 19	3/144 inch
17, 280 or greater	24 inches

Decimal: 27 91 <p1> 95
 Hex: 1B 5B <p1> 65
 BASIC: CHR\$(27);"[<p1>e"

ESC [p1 ;p2 f HVP (Horizontal and Vertical Position): Line terminator. Sets the vertical paper position of the value of <p1> and the print position to the <p2> value. Values are sent as decipoints. HVP can position printing inside margins. The vertical position can not exceed the form length and the horizontal position cannot exceed the maximum width for the printer.

Decimal: 27 91 <p1> 52 96
 Hex: 1B 5B <p1> 3B <p2>66
 BASIC: CHR\$(27);"[<p1><p2>;f";

ESC [p1 j HPB (Horizontal Position Backward): Line terminator. Moves the print position left of the current position by the distance specified in <p1>. Values are sent as decipoints. The print position is set to the left margin if the <p1> value would exceed the margin. An HPB with a <p1> value of zero is ignored.

Decimal: 27 91 <p1> 106
 Hex: 1B 5B <p1> 6A
 BASIC: CHR\$(27);"[<p1>j";

ESC [p1 k VPB (Vertical Position Backwards): Line terminator. Moves the paper in reverse by the distance specified by p1. Values can be sent as decipoints. The paper position is set to the top margin if the p1 value exceeds the margin. A VPB with a p1 value of 5 decipoints or less is ignored.

Decimal: 27 91 <p1> 107
 Hex: 1B 5B <p1> 6B
 BASIC: CHR\$(27);"[(<p1>d";

Margins and Tabs

ESC H	<p>HTS (Horizontal Tab Set): Sets a tab at the current print position and updates any existing horizontal tab table. A total of 22 tabs can be set. If this number is exceeded, the leftmost 22 tabs will be returned.</p> <p>Decimal: 27 72</p> <p>Hex: 1B 48</p> <p>BASIC: CHR\$(27);"H";</p>								
ESC J	<p>VTS (Vertical Tab Set): Sets a tab at the current print position and updates any existing vertical tab table. A total of 12 tabs can be set. If this number is exceeded, the 12 tabs closest to the top of the page will be retained.</p> <p>Decimal: 27 74</p> <p>Hex: 1B 5A</p> <p>BASIC: CHR\$(27);"J"</p>								
ESC [p1 g	<p>TBC (Tab Clear): Clears horizontal or vertical tab stops based on the p1 value as follows:</p> <table><tr><td>p1 = 0</td><td>Clears horizontal tab at current print position.</td></tr><tr><td>p1 = 1</td><td>Clears vertical tab at current print position.</td></tr><tr><td>p1 = 3</td><td>Clears all horizontal tabs.</td></tr><tr><td>p1 = 4</td><td>Clears all vertical tabs.</td></tr></table> <p>More than one parameter can be used.</p> <p>Example: To clear all horizontal and vertical tabs, send:</p> <p>Decimal: 27 91 <p1> 103</p> <p>Hex: 1B 5B <p1> 67</p> <p>BASIC: CHR\$(27);"["<p1>;"g";</p>	p1 = 0	Clears horizontal tab at current print position.	p1 = 1	Clears vertical tab at current print position.	p1 = 3	Clears all horizontal tabs.	p1 = 4	Clears all vertical tabs.
p1 = 0	Clears horizontal tab at current print position.								
p1 = 1	Clears vertical tab at current print position.								
p1 = 3	Clears all horizontal tabs.								
p1 = 4	Clears all vertical tabs.								
ESC [p1; p2; p3 r	<p>GENFD (Forms Definition): Establishes the form length <p1>, the top margin <p2>, and the bottom margin <p2> in decipoints. Default parameters are for an 11-inch (7, 920 decipoints) long form with a top and bottom margin of zero.</p> <p>p1 = maximum allowable length is 24 inches (17, 280 decipoints).</p> <p>p2 - top of page to first print line</p> <p>p3 - non-printable area at bottom of form</p> <p>Decimal: 27 91 <p1> <p2> <p3> r</p> <p>Hex: 1B 5B <p1> <p2> <p3></p> <p>BASIC: CHR\$(27);"["<p1>;<p2>;<p3>r";</p>								

Sequence	Explanation
ESC [r	Default values of 11-inch form length, zero top and bottom margins.
ESC [8280 r	11.5-inch form length, default top and bottom margins of zero
ESC [; 720 r	Default length of 11 inches, top margin of 1-inch. Default bottom margin of zero.
ESC [; ; 720 r	Default length of 11 inches, default top margin of zero, and a 1-inch bottom margin.
ESC [7920 ; 360 ; 360 r	11-inch form length, 1/2-inch top and bottom margins.

Decimal: 27 91 <p1> <p2> <p3> 114

Hex: 1B 5B <p1> <p2> <p3> 72

BASIC: CHR\$(27);"[(<p1>;<p2>;<p3>r";

ESC [p1; p2 s GENSLR (Set Left/Right Margins): The p parameters are distances from the left edge of the printable area of the paper. Parameter <p1> sets the left margin and <p2> sets the right margin. An omitted parameter clears that margin. Invalid parameters set the left margin to zero (column 1) and the right margin to 9, 504 decipoints (column 136 at 10 cpi for the 13.6 inch machines).

A new left margin takes effect following any line terminator that normally calls for a print position set to the left. A new right margin takes effect when the print position reaches the new margin.

Margin settings stored as decipoint values are enforced to the nearest 1/120 of an inch. Characterprinting operates at 1/120 of an inch.

Decimal: 27 91 <p1> <p2> 115

Hex: 1B 5B <p1> <p2> 73

BASIC: CHR\$(27);"[(<p1><p2>s";

NOTE: There is a physical left margin of .6 to 1.6 inches from the edge of the paper to the first printable column. This distance is adjustable by sliding all four tractors sideways. The margins set with this sequence begin at the first physical print position, not at the edge of the paper.

ESC [p1 ; ... p22; u

GENHTS (Multiple Horizontal Tab Set): Sets up to 22 horizontal tabs. The p parameters are set in decipoints.

If more than 22 tabs are set, the highest numbered tabs (farthest right) will be pushed out of the tab table. Tabs set in front of the left margin or beyond the right margin are not usable. Moving the margins will make them active.

Example: To place tabs at columns 10, 20, and 40 at 10 cpi, send ESC [10 ; 40 ; 20 u (tabs can be specified in any order).

Decimal: 27 91 <p1> 59 <p2> 59 ... <p22> 59 117

Hex: 1B 5B <p1> 3B <p2> 3B ... 3B <p22> 3B 75

BASIC: CHR\$(27);"[(<p1>;<p2>; ... ;<p22>;u"

ESC [p1 ; ...; p12 ; v

GENVTS (Multiple Vertical Tab Set): Sets up to 12 vertical tabs. The p parameters are set in decipoints. If more than 12 tabs are set, the 12 tabs nearest the top of form will be retained. If a tab is set in the top margin area, it will be stored but will not be active until the margin is moved. If a tab is set beyond the bottom margin, attempting to move to that tab will advance the paper to the next top of form.

Decimal: 27 91 <p1> 59 <p2> 59 ... <p12> 59 118

Hex: 1B 5B <p1> 3B <p2> 3B ... <p12> 3B 76

BASIC: CHR\$(27);"[(<p1>;<p2>; ... ;<p12>;v";

Font Handling and Enhancements

ESC [p1; p2 SP B

GSM (Graphic Size Modification): This sequence modifies the vertical <p1> and horizontal <p2> size of expanded and oversize characters. When using expanded characters, the currently selected font style is used. Oversize uses its own distinct font style.

Parameter values are percentages of the normal size character, so values over 100 are needed for expansion. Expansion factors are obtained by dividing values by 100.

Example: A parameter value of 526 would be divided by 100 to produce an expansion factor of 5 (5X expansion). Values less than 100 are treated as 1X expansion.

X1: 0-199 (Default) X4: 400-499 X7: 700-799

X2: 200-299 X5: 500-599 X8: 800-UP

X3: 300-399 X6: 600-699

Mixed sizes within a line can be top or bottom justified depending on the Program Mode menu option (see VExOpt: Default and VExOpt: Baseline).

The top of an expanded character is used as the starting point for vertical paper movement (line feed). The top or bottom of oversize characters can be used depending on the state of menu option SETUP | FORMAT | MODIFY FORMAT | GENPRTOPS | GROUP 2 | Strap 13.

When this sequence is received with a value of 200 or more, expanded printing starts if the printer is in the text mode (not bar codes, oversize, etc).

Examples:

ESC [; 200 B	X1 Vertical	X2 Horizontal
ESC [200 ; 200 b	X2 Vertical	X2 Horizontal
ESC [800 ; 400 B	X8 Vertical	X4 Horizontal

During vertically expanded printing, blank lines (lines with no printed characters) are not expanded from the current lpi setting.

Decimal: 27 91 p1 59 p2 32 66
Hex: 1B 5B p1 3B p2 20 42
BASIC: CHR\$(27);"[<p1>;<p2>B";

ESC [p1 ; p2 SP G

SPI (Spacing Increment): This sequence is used to set line spacing (p1) and character spacing or pitch (p2). If the parameter is missing or zero, the spacing remains unchanged. In the native mode, p1 can range from 1 to 17, 280 decipoints (24 inches). The printable area (between the top and bottom margin) can not be exceeded. The range of p2 is dependent on the font and will be ignored if exceeded.

LPI Spacing		CIP Spacing	
LPI	p1 (decipoints)	CPI	p2 (decipoints)
3	240	10	72
4	180	12	60
6	120	13.3	54
8	90	15	42
		16.7	36

Decimal: 27 91 p1 59 p2 32 71
Hex: 1B 5B p1 3B p2 20 47
BASIC: CHR\$(27);"[<p1>;<p2>G";

ESC [p1 ; pn... m

SGR (Select Graphic Rendition): Selects font style and enhancements (bold and underline). One font designator plus any number of enhancements can be entered in the escape sequence using the parameter values in the following table. If the requested font is not installed, the default font is selected.

Parameter	Enhancement
0	Cancel all print enhancements
1	Bold (enhancement)
4	Underline (enhancement)
5	Double Wide
21	Underline
22	Cancel Bold
24	Cancel Underline
25	Cancel Expanded
26	Cancel Proportional

Parameter	Font
10	Default Font - Data Processing
11	Gothic Draft Font
12	Character Graphics
13	Gothic NLQ font
14	Courier NLQ Font
15	High Speed Draft Font
16	OCR-A
17	OCR-B
18	Italic NLQ Font or Download A*
19	Correspondence or Download B*

*A download font (if loaded) overrides any other font.

Examples:

For Gothic NLQ font underlined send:

ESC [4 ; 13 m

To cancel underlining and retain Gothic NLQ - send one of the following:

ESC [; 13 m

ESC [0 ; 13 m

ESC [0 m

ESC [24m

Decimal: 27 91 <p1> ; <pn> m

Hex: 1B 5B <p1> 3B ... <pn> 6D

BASIC: CHR\$(27);"[<p1>;...<pn>m";

ESC [p1; ... pn h

SM (Set Mode): Sets the mode or modes specified by the parameters listed below. Parameters preceded by the greater than sign are privately defined modes and should be sent separately.

Parameter Number	Mode Mnemonic	Mode Function
20	LNМ	Line Feed New Line Mode

LNМ - Line Feed New Line Mode. When using this mode, a received line feed command causes a carriage return (new line). When LNМ is reset, a line feed command only causes a vertical position movement.

The following parameters are privately defined modes.

Parameter Number	Mode Mnemonic	Mode Function
>1	GENPRM	Proportional Print Mode
>2	GENC1C	C1 Control Code Mode
>5	GENCS2	Character Set 2 Mode

GENPRM (Proportional Print Mode): Enables proportional printing. This mode does not apply to the oversize character feature. When reset (default), characters are spaced at the current cpi.

GENC1C (C1 Control Code Mode - PC Set 1): When set, it allows the use of C1 control codes. When reset, 80H - 9FH are ignored. The default state is set using ANSI emulation option 6.

GENCS2 (Character Set 2 Mode - PC Set 2): Selects character set 2 of any of the 8-bit international character sets. The default state is set using option strap 7 in the ANSI emulation options.

Example: To print proportional, send ESC [> 1h.

Decimal: 27 91 62 49 104

Hex: 1B 5B 3E 31 68

BASIC: CHR\$(27);"[>1h";

ESC [p1 ... pn1

RM (Reset Mode): Resets any modes turned on by the Set Mode command above. Parameters and syntax are the same.

ESC] 5

BFL (Begin Font Load): This sequence is not honored when self- test determines that the download font option is not installed. Permits downloading of customer-defined font characters into printer nonvolatile memory from the host. Loading is terminated when an ESC \ sequence is received.

Decimal: 27 93 53

Hex: 1B 5D 35

BASIC: CHR\$(27);"]5";

ESC [p1 SP]

GENDFC (Download Font Control): Using the serial interface, this command allows the host to see if at least one valid font is loaded (p1=p2). The printer sends DCS 30H 30H ST if a font is loaded, DCS 44H 45H ST if no font is loaded. It also provides the capability to erase the download font area (p1=1).

Decimal: 27 91 <p1> 32 125

Hex: 1B 5D <p1> 20 7D

BASIC: CHR\$(27);"[<p1>";

Graphics

The ANSI emulation graphics mode provides both horizontal and vertical dot plotting methods. These methods enable the printing of ASCII characters in their binary code form. Since each character has a unique pattern of 1s and 0s (dots and voids) that make up its binary code, the correct placement of these binary forms enables you to form larger images on the paper.

For clarity in the text, a binary 1 (a printed dot) is shown as an X and a binary 0 (empty dot position) will be shown as a 0.

Six-Bit Graphics

In the graphics mode, only the low order six bits of a character are used (bits 1-6). Looking at an ASCII code chart, the question mark character (?) is represented by the binary number 111111 10 (bit 1 - bit 7). Since only the first 6 bits are used, a "?" prints six dots on the paper. An asterisk "*" is represented by 010101 which prints the following:

Horizontal Graphics	Vertical Graphics
0X0X0X	0
	X
	0
	X
	0
	X

Notice that in horizontal graphics the character is printed on a single horizontal dot row. In vertical graphics, the character is printed six dots high, one character per dot column.

Using the question mark that prints all dots, a series of these characters in horizontal graphics produces a one-dot-high solid line across the paper. The same character in vertical graphics produces a six-dot high band across the paper.

By repeating, omitting, and mixing characters across a page, images such as graphics, charts, and pictures can be produced.

Dot Patterns and Densities

The chart on the next page shows the dot patterns for each of the ASCII characters. Each character represents six dots or dot positions, and their spacing is dependent on the density selected. At 60 dpi density, the dots are spaced 1/60 inch apart. At 120 dpi, each character represents six dots spaced 1/120 inch apart.

This chart shows the dot patterns for the ASCII characters needed to cover all dot/void combinations. Other valid characters (although they are repeat patterns of the characters in the chart) are 20H-3FH.

Character	Value	Dots	Character	Value	Dots
@	40H	000000	'	60H	00000X
A	41H	X00000	a	61H	X0000X
B	42H	0X0000	b	62H	0X000X
C	43H	XX0000	c	63H	XX000X
D	44H	00X000	d	64H	00X00X
E	45H	X0X000	e	65H	X0X00X
F	46H	0XX000	f	66H	0XX00X
G	47H	XXX000	g	67H	XXX00X
H	48H	000X00	h	68H	000X0X
I	49H	X00X00	i	69H	X00X0X
J	4AH	0X0X00	j	6AH	0X0X0X
K	4BH	XX0X00	k	6BH	X00X0X
L	4CH	00XX00	l	6CH	00XX0X
M	4DH	X0XX00	m	6DH	X0XX0X
N	4EH	0XXX00	n	6EH	0XXX0X
O	4FH	XXXX00	o	6FH	XXXX0X
P	50H	0000X0	p	70H	0000XX
Q	51H	X000X0	q	71H	X000XX
R	52H	0X00X0	r	72H	0X00XX
S	53H	XX00X0	s	73H	XX00XX

Character	Value	Dots	Character	Value	Dots
T	54H	00X0X0	t	74H	00X0XX
U	55H	X0X0X0	u	75H	X0X0XX
V	56H	0XX0X0	v	76H	0XX0XX
W	57H	XXX0X0	w	77H	XXX0XX
X	58H	000XX0	x	78H	000XXX
Y	59H	X00XX0	y	79H	X00XXX
Z	5AH	0X0XX0	z	7AH	0X0XXX
[5BH	XX0XX0	{	7BH	XX0XXX
\	5CH	00XXX0		7CH	00XXXX
]	5DH	X0XXX0	}	7DH	X0XXXX
^	5EH	0XXXX0	~	7EH	0XXXXX
_	5FH	XXXXX0	?	7FH	XXXXXX

X=dot and 0=no dot (void)

Horizontal Format

Graphics data printed in horizontal format is comprised of a stream of bytes from left to right across each dot row.

This chart shows that byte 1 (or character 1) in row 1 prints its six bits from left to right in a single dot row. The next byte (byte 2) prints its six bits, representing a character, in the same dot row across the page.

Byte → Row ↓	Byte 1	Byte 2	Byte n
1	1 2 3 4 5 6	1 2 3 4 5 6	...1 2 3 4 5 6
2	1 2 3 4 5 6	1 2 3 4 5 6	...1 2 3 4 5 6
3	1 2 3 4 5 6	1 2 3 4 5 6	...1 2 3 4 5 6
.
.
6	1 2 3 4 5 6	1 2 3 4 5 6	...1 2 3 4 5 6

Vertical Format

In vertical format, each byte (or character) occupies six dot rows of one column. Each character is one dot wide and six dots high. The next character (byte 2) is printed beside the first, moving from left to right across the page.

Byte →	1	2	3	...n
Row	bit	bit	bit	...bit
1	1	1	1	...1
2	2	2	2	...2
3	3	3	3	...3
4	4	4	4	...4
5	5	5	5	...5
6	6	6	6	...6

Eight-Bit Graphics

- **Horizontal Format**

Graphics data printed in horizontal format is comprised of a stream of bytes from left to right across each dot row.

This chart shows that a byte 1 (or character 1) in row 1 prints its eight bits from left to right in a single dot row. The next byte (byte 2) prints its eight bits, representing a character, in the same dot row across the page.

Byte → Row ↓	Byte 1	Byte 2	Byte n
1	1 2 3 4 5 6 7 8	1 2 3 4 5 6 7 8	...1 2 3 4 5 6 7 8
2	1 2 3 4 5 6 7 8	1 2 3 4 5 6 7 8	...1 2 3 4 5 6 7 8
3	1 2 3 4 5 6 7 8	1 2 3 4 5 6 7 8	...1 2 3 4 5 6 7 8
.
.
8	1 2 3 4 5 6 7 8	1 2 3 4 5 6 7 8	...1 2 3 4 5 6 7 8

- **Vertical Format**

In vertical format, each byte (or character) occupies six dot rows of one column. Each character is one dot wide and six dots high. The next character (Byte 2) is printed beside the first, moving from left to right across the page.

Byte →	1	2	3	...n
Row	bit	bit	bit	...bit
1	1	1	1	...1
2	2	2	2	...2
3	3	3	3	...3
4	4	4	4	...4
5	5	5	5	...5
6	6	6	6	...6
7	7	7	7	...7
8	8	8	8	...8

- **Other Graphics Considerations**

In horizontal format, an LF causes the paper to advance one or two dot rows based on the vertical dot density, regardless of whether 6-bit or 8-bit graphics has been selected.

In vertical format, the paper is advanced as the dot rows (6 or 8, depending on the graphics mode) are printed.

Graphics Sequences

ESC P DCS (Device Control String): Enters dot graphics mode at the density and format previously selected by the ESC [`<p1>` ;`<p2>` ; `<p3>` q sequence. Following this sequence, the printer prints discrete dots and leaves spaces based on the 1s and 0s in the low order six bits of each byte received, forming graphic dot rows from left to right. To exit from dot graphics mode, use ESC \.

While in graphics mode (after ESC P and before the ESC \ sequence), 8-bit graphics can be printed instead of 6-bit by using one of the following sequences:

ESC " 1 n 1 `<data bytes>` 60 dpi horizontal

ESC " 2 n 1 `<data bytes>` 120 dpi horizontal

ESC " 3 n 1 `<data bytes>` Uses current horizontal and vertical density

n1 = number of data bytes to follow.

`<data bytes>` = n1 bytes of graphics data

When the number of bytes of 8-bit data specified by n1 have been processed, and prior to receiving an ESC \ sequence, the data will print as 6-bit graphics.

Decimal: 27 91 80

Hex: 1B 5B 50

BASIC: CHR\$(27);P";

ESC [p1 b REP (Repeat Text or Dot Graphics Character): Repeats the single preceding character p1 times. If p1 is 0 or unspecified, it is set to 1. The maximum value for p1 is 32, 767.

Decimal: 27 91 <p1> 98

Hex: 1B 5B <p1> 62

BASIC: CHR\$(27);"["<p1>b";

ESC [p1 ; p2 ; p3 q

GENGRM - Select Graphics Mode: Selects the graphics mode, format, and horizontal or vertical density for dot graphics.

IMPORTANT This sequence must be sent before entering the graphics mode with ESC P.

The first parameter selects the graphics mode, the second parameter selects the vertical spacing, and the third parameter selects the horizontal dot spacing.

p1 value	Selects Graphics Format
null	Reserved: Vertical format 60h x 72v if no <p2> or <p3>
0	Reserved: Vertical format 60h x 72v if no <p2> or <p3>
1	Reserved: Vertical format 120h x 72v if no <p2> or <p2>
2	Reserved: Vertical format 120h x 144v if no <p2> or <p3>
3	Reserved: Sequence ignored
4	Horizontal format 60h x 72v if no <p2> or <p3>
5	Similar to 4, above, if <p3> = 5, 6, 7, else ignore
6+	Reserved: Sequence ignored

NOTE: <p2> and <p3> are ignored in this mode.

p2	Selects Vertical Density
null	72dpiv (p1=4 only)
0-6	144dpiv
7+	72dpiv

p3	Selects Horizontal Density
null	60dpih (p1=4 only)
0-3	Reserved: Leave current value unchanged
4	Reserved: Leave current value unchanged
5	Reserved: 120dpih
6-7	120dpih
8-10	Reserved: 60dpih
11+	60dpih

Decimal: 27 91 <p1> <p2> <p3> 112
Hex: 1B 5B <p1> <p2> <p3> 70
BASIC CHR\$(27);"[<p1><p2><p3>q";

EVFU

Downline vertical tab loading is accomplished through the EVFU. The EVFU allows loading a form table with a minimum form length of .33 inches (240 decipoints) and a maximum length of 24 inches (17, 280 decipoints).

Since the maximum length is 24 inches, the number of lines is dependent on the lpi setting. 3 lpi = 72 lines, 4 lpi = 96 lines, 6 lpi = 144 lines, and 8 lpi = 192 lines. Exceeding the maximum causes a fault.

Downloading the EVFU

- The vertical format type must be set to VtType: Emul EFU through the control panel using the Program Mode.
- No paper instruction lead (P1) is required.
- When the printer has an EVFU table loaded, VFU is displayed on the control panel.

ESC]! Start EVFU table loading sequence. Each line of the form requires an entry. Dummy values are required in lines with no channel. Two bytes are required for each line of the form. Loading is terminated by the ESC \ sequence.

Decimal: 27 93 33
Hex: 1B 5D 21
BASIC: CHR\$(27);"]!";

Loading the Table

The first table location is normally loaded with the channel 1 code. This is defined as the top-of-form (TOF) channel. The table may be left without channel 1, and a command to skip to channel 1 will cause a normal form feed as though there were no VFU. Two bytes are loaded for each line of the form to be controlled. One or more channel numbers may be indicated in the two- byte code.

The format of two-byte channel control code is:

Bit Number	8	7	6	5	4	3	2	1
Channel Number	x	one	6	5	4	3	2	1
First Byte	x	one	y	y	y	y	y	y

Bit Number	8	7	6	5	4	3	2	1
Channel Number	x	one	12	11	10	9	8	7
Second Byte	x	one	y	y	y	y	y	y

y: 0 = no stop in channel
 1 = stop in channel

x: bit has no meaning

NOTE: To make characters acceptable, bit 7 must be set.

Each channel control code page of bytes has the capability to indicate multiple channels since each channel indication has a unique bit position, which is either ON=1 or OFF=0.

Table 19 Table of Channel Codes

Decimal Value		Binary Value		ASCII Character		Remarks
1	2	1	2	1	2	
64	64	1000000	1000000	@	@	Fillers: see Note on page 72.
65	64	1000001	1000000	A	@	Channel 1
66	64	1000010	1000000	B	@	Channel 2
68	64	1000100	1000000	D	@	Channel 3
72	64	1001000	1000000	H	@	Channel 4
80	64	1010000	1000000	P	@	Channel 5
96	64	1100000	1000000	'	@	Channel 6
64	65	1000000	1000001	@	A	Channel 7
64	66	1000000	1000010	@	B	Channel 8
64	68	1000000	1000100	@	D	Channel 9
64	72	1000000	1001000	@	H	Channel 10
64	80	1000000	1010000	@	P	Channel 11
64	96	1000000	1100000	@	'	Channel 12

Table 20 BASIC Programming Example for EVFU Table Loading

Program Instruction		Remarks
1500	Width "LPT1:" 255	Required by some BASIC languages to avoid auto LF at column 80.
1510	LPRINT CHR\$(27);"]";	Enables EVFU loading.
1520	LPRINT CHR\$(65);CHR\$(64);	Resets TOF, Channel 1 See Table of Channel Codes.
1530	FOR I=1 to 4	
1531	LPRINT CHR\$(64);CHR\$(64);	4 filler lines
1532	Next I	
1540	LPRINT CHR\$(68);CHR\$(64);	Selects Channel 3. See Table of Channel Codes
1550	FOR I=1 to 16	
1551	LPRINT CHR\$(64);CHR\$(64);	16 filler lines
1552	NEXT I	
1560	LPRINT CHR\$(72);CHR\$(64);	Selects channel 4. See Table of Channel Codes
1570	FOR I=1 to 31	
1571	LPRINT CHR\$(64);CHR\$(64);	31 filler lines.
1572	NEXT I	
1580	LPRINT CHR\$(80);CHR\$(64);	Selects channel 5. See Table of Channel Codes
1590	FOR I=1 to 8	
1591	LPRINT CHR\$(64);CHR\$(64);	8 filler lines
1592	NEXT I	
1600	LPRINT CHR\$(64);CHR\$(66)	Selects channel 8. See Table of Channel Codes
1610	LPRINT CHR\$(27);"\";	Exit EVFU loading.
1620	END	

EVFU Default

The default EVFU will be generated based on the current form length and lpi setting under the following conditions:

- when the printer is initialized
- when either the forms definition or lpi setting is changed
- when the start EVFU load escape sequence ESC] is immediately followed by the end load sequence ESC \
- when the emulation is changed from P Series or Dataproducts, to ANSI the following chart shows how the default EVFU table is defined.

Channel	Description
1	Top Margin (first line)
2	Bottom Margin (last line)
3	Single Spacing
4	Double Spacing
5	Triple Spacing
6	Half Form

Channel	Description
7	Quarter Form
8	Tenth Line
9	Bottom of Form (bottom margin)
10	Bottom of Form minus one line
11	Top of Form minus one line (last line of form)
12	Top of Form

Skip to Channel Command

ESC [p1 ; p2 ! p

GENVFU (VFU Channel Command): Commands vertical paper movement to the channel specified by the number formed by p1 and p2. Valid channel numbers are in the range 1 - 12.

0;1 - selects channel 1

0;9 - selects channel 9

1;1 - selects channel 11

Channel 1 is always used for TOF; channel 12 is always used for vertical tab. When the channel number is greater than 12, the program defaults to channel 1. If the table has not been loaded and a channel command is received, it is ignored.

Decimal: 27 91 <p1> ; <p2> ! 112

Hex: 1B 5B <p1> 3B <p2> 21 70

BASIC: CHR\$(27);"[<p1>;<p2>!p";

Bar Codes

Setting Bar Code Parameters

Select the style, height, spacing, orientation, and print density for the bar code using the following escape sequence. The second line in the example (written in BASIC) shows the parameters that are the default values for the printer.

ESC [<p1>;<p2>;...;<p10>}

Example:

```
LPRINT CHR$(27);"[4;9;1;2;6;2;6;2;0;0]";
```

p1: Style			
0	Interleaved 2 of 5	10	Codabar b/n
1	(Reserved for future use)	11	Codabar c/*
2	(Reserved for future use)	12	Codabar d/e
3	(Reserved for future use)	13	UPC-A
4	Code 3 of 9 (default)	14	UPC-E
5	EAN-8	15	Code 93
6	EAN-13	16	Code 128 (A, B, C)
7	Code 11	17	(Reserved for future use)
8	(Reserved for future use)	18	(Reserved for future use)
9	Codabar a/t	50	POSTNET (see note below)

NOTE: When using POSTNET, parameters <p2> through <p10> are invalid. If these parameters are changed, they will be retained in memory and will affect other styles if selected.

Bar Code Dimensions

NOTE: The following dimensions are for barcodes printed at 0 and 180 degrees rotation. Barcodes printed at 90 or 270 degrees rotation will be compressed by a 6:5 ratio due to the differences in size of the horizontal and vertical grids.

p2 Barcode height in 1/2 inch increments
 Minimum: 1=1/12 inch
 Maximum: 120=10 inches
 Default: 9=9/12 inch (3/4 inch)
 Human-readable line is not included in height.

p2 Human-readable line
 0 = do not print human readable line
 1 = print human readable line (default)

p4	Narrow bar width, number x 1/120 inch Default: 2(2/120 inch, approximately .017 inch) Range: 2, 4, 6, ...126
p5*	Wide bar width, number x 1/120 inch Default: 6(6/120 inch, approximately .050 inch) Range: 2, 4, 6, ...254
p6	Narrow space width, number x 1/120 inch Default: 6 (6/120 inch, approximately .017 inch) Range: 2, 4, 6, ...126
p7*	Wide space width, number x 1/20 inch Default: 6 (6/120 inch, approximately .050 inch) Range: 2, 4, 6, ...254
p8*	Intercharacter space width, number x: 1/120 inch Default: 2 (2/120 inch, approximately .017 inch) Range: 2, 4, 6, ...126

* Parameters <p5>, <p7>, and <p8> are not programmable in some barcode styles since they are generated from other parameters.

Default Barcode Characteristics

p1 = 4	Code 39
p2 = 9	3/4 inch height
p3 = 1	Human readable line printed
p4 = 2	Narrow bar width 1/60 inch
p5 = 6	Wide bar width 1/20 inch
p6 = 2	Narrow space width 1/60 inch
p7 = 6	Wide space width 1/20 inch
p8 = 2	Intercharacter space width 1/60 inch
p9 = 0	No rotation, use currently selected font
p10 = 0	Horizontal print density 60 dpi

Human Readable Line (HRL)

The human readable line is printed 0.10 inch below the barcode symbol. The height of the HRL and the 0.10 inch space are not included in the barcode height parameter (p2).

A diamond symbol appearing in the human readable line indicates one of the following conditions:

- Margin overrun. The data to be printed exceeds the available space remaining inside the programmed margins.
- The DEL character has been received while printing in a barcode style that permits the use of all 128 ASCII characters.
- An invalid character has been received. An example of this would be a letter “A” sent to the printer while printing a style 5 barcode. Style 5 (EAN-8) only accepts the digits 0-9.

Font Styles and Enhancements

Non-rotated barcodes can be printed with an HRL in any of the fonts available to the printer.

If enhancements are desired (e.g., bold, underline, or expanded) the HRL must be printed using the normal text mode. Print the barcode symbol(s) without the HRL first. Exit the barcode mode and print the HRL using the normal text mode with enhancements.

Rotated barcodes use a special font for the human readable line.

Spacing and Barcode Editing Aids

There is a 0.25 inch space called a quiet zone at the beginning and end of every barcode. As a result, the minimum distance between two horizontal barcodes is 0.50 inch.

Most barcode styles accept commas, spaces, and horizontal tabs as delimiters to separate barcodes. A comma adds no additional space between barcodes, so the separate is the width of the quiet zone for a total 0.60 inch separation. A horizontal tab adds the appropriate number of empty spaces to go to the next tab.

Oversize Character Font

The oversize font is composed of special block-style characters that can be expanded 156 times the size of standard fonts. This will produce letters up to 15.25 inches (388mm) high by 13 inches (330mm) wide. Oversize characters can be rotated 90, 180, or 270 degrees.

Do not confuse oversize characters with expanded characters. The expanded character feature, (standard in your printer), expands all existing fonts up to eight times the normal size. These characters are not rotatable.

The oversize character feature works with the ANSI protocol.

Entering and Exiting Oversize

The following sequences are used to enter, rotate, and exit oversize printing:

- ESC [0 | Exit oversize printing.
- ESC [1 | Select oversize font with no rotation.
- ESC [2 | Select oversize font with 90 degree rotation.
- ESC [3 | Select oversize font with 180 degree rotation.
- ESC [4 | Select oversize font with 270 degree rotation.

LPRINT CHR\$(27);"[0 |"; or

LPRINT CHR\$(27);"[0 |";CHR\$(124);

Once oversize has been turned on, it will remain on until an ESC [0 | sequence is used to turn it off. It does not turn off due to line terminators (CR and LF).

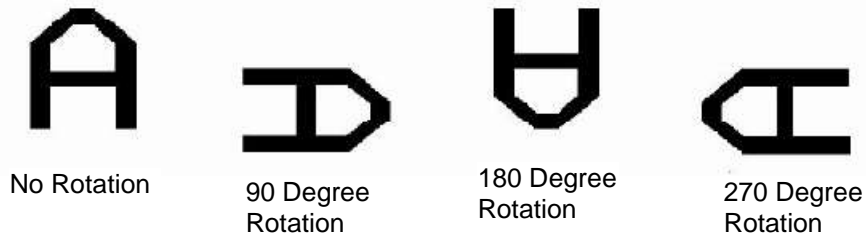

Selecting Size

ESC [p1;p2 B is the sequence used to set the vertical (p1) and horizontal (p2) size of the oversize characters. A p1 value of 300 would increase the vertical size of the character 300% or three times.

The last two digits of each parameter are necessary to comply with the ANSI standard, but are ignored by the printer. Using the above example p1, any three-digit number starting with 3 (300-399) will be interpreted as three times normal size. Likewise, 400-499 equals four times, 1200-1299 equals 12 times increase in size, and so on. The maximum size is 15600;15600(156 times) and the minimum or default is 200;200 (two times).

Since this same sequence is used to change size in the expanded mode, the parameters must be cleared to normal size, ESC [100 ; 100 B, to prevent entering expanded mode when oversize is turned off.

Mnemonic: ESC [<p1>; <p2> B
 Decimal: 27 91 <p1> 59 <p2> 66
 Hex: 1B 5B <p1> 3B <p2> 42
 BASIC: CHR\$(27);“[”;<p1>;<p2>;B”;

Size Parameters for Rotation

The <p1> and <p2> size parameters are always relative to a rotation angle of zero degrees. That is, the characters are expanded first and then rotated.

Spacing Between Characters

For non-rotated characters and characters rotated 180 degrees, the horizontal spacing between characters is 1/60 inch times the <p2> parameter.

For characters rotated 90 or 270 degrees, the horizontal spacing between characters is 3/60 inch times the p1 parameter.

Vertical spacing is dependent on vertical paper move commands (LF, CR, VPR, etc.) the state of menu option GenPrtOpts/Group 2/Strap 13, and the character size and line spacing currently in effect.

Emulation Exceptions

Font Styles

- Correspondence font is not available, so its mapped to Gothic.
- Font styles are best fit - characters might look slightly different.
- Proportional printing is only available for 10 CPI DP for US. On the Genicom 5000, proportional print is supported for most CPI, font style, and language combinations. However, the Genicom 5000 does not print at all when proportional mode is selected in combination with Draft.

Character Pitch

Not every CPI available on the Genicom 5000 is supported. The closest available CPI is used including 5, 6, 6.67, 8.33, 8.57, 10, 12, 13.33, 15, 16.67, 17.14, and 20 CPI.

Character Sets

The list below shows languages and character sets that are available on the Genicom 5000 printer via escape sequences, but are not supported at all on the TallyGenicom 6800 printer.

Unsupported Languages	Character Sets
French B	CP 853
Dutch	CP 860
Swiss	CP 864
Yugoslavian	CP 865
Turkish	CP 867
Greek	USSR GOST
	Polish
	Latin 3
	Latin 4
	ISO 8859-6 Latin/Arabic

Below is a list of all the Genicom 5000 sets that are supported.

Unsupported Languages	Character Sets	
US	United Kingdom A	ISO 8859-2 Latin 2
German	Italian (ISO0	ISO 8859-5 Latin/Cyrillic
French A	Spanish (ISO)	ISO 8859-7 Latin/Greek
French Canadian	CP 437	ISO 8859-8 Latin/Hebrew
Italian	CP 850	ISO 8859-9 Latin 5
United Kingdom	CP 852	
Spanish	CP 855	
Danish/Norwegian A	Cp 863	
Danish Norwegian B	CP 866	
Danish Norwegian C	Greek CP 437	
Danish Norwegian D	DEC Multinational	
Swedish/Finnish A	Roman 8	
Swedish/Finnish B	Turkish 8-bit CP	
Swedish/Finnish C	Greek CP 851	
Swedish/Finnish D	ISO 8859-1 Latin 1	

Barcodes

- Code 93, Matrix 2 of 5, Industrial 2 of 5, and Code DCB barcodes are not supported.
- Barcode heights are set to the nearest 1/10".
- Barcodes are allowed to print all the way to the maximum right margin. On the Genicom 5000, when the right margin is set beyond 13.2 inches, barcodes still only print to 13.2 inches.
- Font of HRCs does not match the current text font style. On the Genicom 5000, barcodes' HRCs print using the current text font style and attributes. The 6800 prints them using the Data Processing font with no attributes.
- No solid block is printed when a barcode goes beyond the right margin. On the Genicom 5000, when barcodes extend beyond the right margin, a solid rectangular block is printed.

Block Characters

Block characters are allowed to print all the way to the maximum right margin. On the Genicom 5000, when the right margin is set beyond 13.2 inches, block characters still only print 13.2 inches.

Emulation Enhancements

The following escape sequences have been added:

POSTNET barcodes ESC [50 ; ... }

PLANET barcodes ESC [53 ; ... }

Printronix P5000

The Printronix P5000 emulation is defined by *LinePrinter Plus for Line Matrix Printers Programmer's Reference Manual*. The chapter on P-Series Printer Emulation was used. The following exceptions exist:

1. <SFCC>c Download New Character Shape - not supported.
2. <SFCC>V Download a Character Set Overlay - not supported.
3. Basic character set select on the panel is not supported. <SFCC>PSET;n and <SFCC>Rn react differently based on which basic character set is selected on the panel of the Printronix printer. Since we don't have this panel setting, we assume the basic character set to be ECMA Latin 1.
4. <SFCC>lxyz and <SFCC>OSET;n offer characters that our printer does not support, including barcode, Greek, graphics and scientific.
5. Some of the character set mappings supported by <SFCC>lxyz do not match exactly the character mappings supported by our printer. In these cases, the closest match was selected.
6. <SFCC>PMODE;n allows DP text at various CPIs to be printed upside down. This feature is not supported.

Printronix P6000

The Printronix P6000 emulation is defined by P6000 Series Multifunctional Line printer Pedestal Models.

With the exception of one control code (Hex 01), the P6000 emulation is a superset of the P600 emulation. The additional features are similar to those found in Epson and Proprinter emulations. Specific differences are as follows:

1. Printronix does not implement the alternate character set whereas the 6800 Series P6000 Emulation does.
2. 6800 Series P6000 Emulation can change the alternate character set with the panel to Latin 2.
3. Printronix P6000 manual does not mention 08 hex for elongated text from the P600 emulation. P6000 and 6800 Series P6000 Emulation both accept 08 hex and 0164 hex to elongate text.
4. The Printronix P6000 manual says 0140 hex (RESET) resets horizontal tabs but their printer does not so our emulation does not either.
5. Printronix underline is at the same height for normal, superscript, and subscript print. The T6000 Series P6000 Emulation adjusts the placement for underline based on the bottom of the characters.
6. The T6000 Series P6000 Emulation as seven international characters in different languages that are substituted from the original US characters. Printronix substitutes some characters but not the extra seven we substitute.

Printronix P600

This is an emulation of the Printronix P600 as defined by Printronix Manual P- Series User's Reference Manual.

A general exception to the emulation is that the Alternate Character Set selected by the SO control character is the Latin 1 character set. This varies on the P600 depending on the optional font EPROM installed.

There are a number of control panel sections, such as Language, CPI and LPI, not provided by a P6000 that can be used in this emulation.

HP 2564C

The HP 2564C emulation is defined by HP 256x Printer Family Technical Reference Manual, HP Manual Part No. 02564-90905.

This emulation supports the following HP PCL Level 1, PCL Level 2, some PCL Level 3 commands (mainly in the area of font selection), and PCL extensions unique to line matrix printers. These extensions provide for raster graphics, bar code printing, and VFUs.

ESCE	Reset
ESC9	Reset Margins
ESC*b<0-1056>W	Raster Download
ESC*b<0-1056>Y	Move Raster Amount of Lines
ESC*rA	Raster Start Sequence
ESC*r1A	Raster Star Sequence
ESC*rB	Raster Stop Sequence

ESC*r60L	Set Horizontal 60 DPI
ESC*r70L	Set Horizontal 70 DPI
ESC*r120L	Set Horizontal 120 DPI
ESC*r140L	Set Horizontal 140 DPI
ESC*r72V	Set Vertical 72 DPI
ESC*r144V	Set Vertical 144 DPI
ESC&dD	Enable Underline
ESC&d0D	Enable Underline
ESC&d@	Disable Underline
ESC&knG	Enables Auto CR and/or Auto LF
ESC&k0S	Select 10 CPI
ESC&k2S	Select 16.7 CPI
ESC&k4S	Set 12 CPI
ESC&k8S	Set Dbl Size
ESC&i1L	Enable Perf Skip
ESC&i0L	Disable Perf Skip
ESC(0U	Set Primary Lang ASCII
ESC(8U	Set Primary Lang Roman8
ESC(0@	Set Primary Lang Default
ESC(0L	Set Primary Lang Line
ESC(0E	Set Primary Lang Roman8
ESC(1E	Set Primary Lang UK
ESC(0G	Set Primary Lang German
ESC(0F	Set Primary Lang French
ESC(0D	Set Primary Lang Danish
ESC(0S	Set Primary Lang Swedish
ESC(1K	Set Primary Lang Katakana
ESC(0K	Set Primary Lang Japanese
ESC(0O	Set Primary Lang OCRA
ESC(1O	Set Primary Lang OCRB
ESC(s0S	Set Primary Attributes to Upright
ESC(s1S	Set Primary Attributes to Italics

ESC(s0Q	Set Primary font Data Processing
ESC(s1Q	Set Primary font NLQ
ESC(s-1Q	Set Primary font Draft
ESC)0@	Set Secondary Lang Default
ESC)0L	Set Secondary Lang Line
ESC)0E	Set Secondary Lang Rom8
ESC)0U	Set Secondary Lang ASCII
ESC)1E	Set Secondary Lang UK
ESC)0G	Set Secondary Lang Germ
ESC)0F	Set Secondary Lang Fren
ESC)0D	Set Secondary Lang Den
ESC)0S	Set Secondary Lang Swed
ESC)1K	Set Secondary Lang Kata
ESC)0K	Set Secondary Lang Jap
ESC)00	Set Secondary Lang OCRA
ESC)10	Set Secondary Lang OCRB
ESC)s10H	Set Secondary CPI 10
ESC)s12H	Set Secondary CPI 12
ESC)s13.3H	Set Secondary CPI 133
ESC)s15H	Set Secondary CPI 15
ESC)s16.7H	Set Secondary CPI 167
ESC)s0S	Set Secondary Upright
ESC)s1S	Set Secondary Italics
ESC)s0Q	Set Secondary DataP
ESC)s1Q	Set Secondary NLQ
ESC)s-1Q	Set Secondary Draft
ESC(s<1-9999>.<1-9999>H	Set Primary CPI
ESC&l<0-16>V	Do VFU Move
ESC*z<0-128>C	Bar Column Size
ESC*t<0-600>R	Set Density
ESC&a<1-128>L	Set Left Margin
ESC*z<0-128>H	Select Bar Height

ESC&l<0-128>P	Set Page Length
ESC&a<1-128>M	Set Right Margin
ESC&l<0-128>F	Set Text Length
ESC&a<1-128>R	Move Absolute Row
ESC*z<0-128>Q	Select Human Readable Characters
ESC*z<0-128>V	Select Bar Code Type
ESC&l<1-256>W	VFU Download
ESC&l<1-9999>.<1-9999>D	Set LPI
ESC&a<1-128>C	Bar Column
ESC*z*Z	Get Bar Data
ESC&a<1-16383>H	Set Horizontal Cursor Position
ESC&a<1-16383>V	Set Vertical Cursor Position

Emulation Enhancements

The following escape sequences have been added:

POSTNET bar codes ESC * z 20 V

PLANET bar codes ESC * x 23 V

DEC LG01

This emulation is defined by LG01 firmware version Rev 11 (produced by MT), and DEC manual EK-0LG01-UG-001, LG01 600 LPM Text Printer User's Guide.

Where appropriate, the capabilities of the LG01 emulation are extended to take advantage of new capabilities, using LG02 syntax where possible.

Unsupported and ignored escape sequences include:

- ESC;n1;n2!s - select G0/G1 character sets (must use ESC(or ESC) sequences);
- ESC(< - set G0 set = DEC Supplemental;
- ESC(> - set G0 set = DEC Technical;
- ESC(0 - set G0 set = DIP switch default.

Epson FX-1180

Prior to Firmware Version 2.1 of the T6200 Series printers, the Epson FX-100+ was emulated as defined by Epson document P8294017A, FX+ Series Printer User's Manual. Exceptions and enhancements were the same as those for the Proprinter emulation.

Effective in Firmware Version 2.1, the Epson FX-100+ emulation was enhanced to emulate the more current FX-1180. This emulation is defined in the Epson ESC/P Reference Manual. The version of the manual used for the emulation development was date December 1997.

In order to support the FX-1180, the following escape sequences were added to the FX-100+ emulation:

Page Format: ESC (C – Set Page Length in Defined Units

ESC (c – Set Page Format

Print Position Motion:

ESC \ - Set Relative Horizontal Print Position

Spacing: ESC <space> - Set Intercharacter Space

Bar Codes: ESC (B – Select Bar Code Printing

All of the Epson barcodes are supported, including:

Code 39 EAN-8 UPC-A

Interleaved 2 or 5 EAN-13 UPC-E

POSTNET Code 128

Font Selection: ESC k – Select Typeface (0 = Courier; 1 = Gothic)

ESC t and ESC (t – Select Character Set

Table 21 FX-1180 Supported Character Sets

Supported Epson Character Sets	Tally Equivalent Character Sets
ISO8859-1 (Latin 1)	Latin 1 8859-1
ISO8859-2 (Latin 2)	Latin 2 8859-2
ISO8859-7 (Latin/Greek)	Greek 8859-7
ISO Latin 1	Latin 1 8859-1
ISO Latin 1T (Turkish)	Turkish 8859-9
ISO Latin 7 (Greek)	Greek 8859-7
OCR-B	OCR-B
PC437 (US)	Code Page 437
PC437 Greek	Code Page 437G
PC850 (Multilingual)	Code Page 850
PC851 (Greek)	Code Page 851
PC852 (East Europe)	Code Page 852

Table 21 FX-1180 Supported Character Sets

Supported Epson Character Sets	Tally Equivalent Character Sets
PC855 (Cyrillic)	Code Page 855
PC857 (Turkish)	Code Page 857
PC863 (Canada-French)	Code Page 863
PC866 (Russian)	Code Page 866
Roman 8	Roman-8

Table 22 FX-1180 Unsupported Character Sets

Unsupported Epson Character Sets
Abicomp
BRASCII
Bulgaria
Code MJK (CSFR)
Estonia
Hebrew 7, Hebrew 8
ISCII
KU42, TIS11, TIS13, TIS16, TIS17, TIS18, TSM/WIN (Thai)
MAZOWIA (Poland)
PC708
PC720
PC774 (Lithuania)
PC853 (Turkish)
PC860 (Portugal)
PC861 (Iceland)
PC862 (Hebrew)
PC864 (Arabic), PCAR864
PC865 (Norway)
PC Aptec

IBM Proprinter III XL

This is an emulation of the IBM Proprinter III XL as defined by IBM document SA34-2065-1, IBM Proprinter III and Proprinter III XL Guide to Operations.

The following exceptions to the emulation will exist:

The following escape sequences are not supported:

- ESC 8 Disables the paper out sensor.
- ESC 9 Enables the paper out sensor.
- ESC < Turns unidirectional mode ON for one line.
- ESC U Turns unidirectional mode ON.
- ESC i Immediate mode, prints 1 character at a time.
- ESC s Half speed mode.

NLQ Font download is not supported. Standard font download is supported. The following enhancements to the emulation will exist:

1. Various font styles, plus POSTNET and PLANET bar codes, can be selected with the ESC x n command:

n (ASCII)	N (Hex)	Selection
0	00 or 30	Draft
1	01 or 31	Gothic
2	02 or 32	Courier
3	03 or 33	Draft
4	04 or 34	OCR-A
5	05 or 35	OCR-B
@	10 or 40	POSTNET
C	43	PLANET

2. There are a number of control panel selections, such as Language, CPI, and LPI, not provided by the emulated printer that can be used in this emulation.

MTPL

The MTPL emulation is defined by MTPL Emulation Programmer's Application Manual, Part Number 255557-001.

Also included in the MTPL emulation is a bar code and larger character printing (LCP) language which is defined by Barcode and LCP Programmer's Application Manual, MT Part Number 255557-001 attached to the Graphics Applications Manual.

Emulation Differences

The primary purpose for implementing MTPL is to gain compatibility with Tally SIDM printers. The following are differences between the MT360 SIDM printer and the 6800 MTPL Emulation.

Double Underlines

The 6800 MTPL Emulation only allows for one underline row in text, so this attribute was implemented as a single underline. Also, the MT360 printer draws its double underlines 1/180" apart, which on our printer would be 1/72 inch, giving different results.

The Cancel Control Code

On the 6800 MTPL Emulation, the CAN control code (hex 18) removes from the print buffer all characters which have been sent to the printer since the last attribute change. The MT360 printer does not seem to implement this code, though it is described in the MTPL Programmer's manual.

Font Substitutions

The 6800 MTPL Emulation approximates any MT360 fonts that it does not support. The ten font register default setting substitutions are as follows:

Reg #	MT360 Font	6800 Font
Font 0	Draft	Draft
Font 1	Courier NLQ	Courier
Font 2	Courier LQ	Courier
Font 3	San Serif NLQ	Gothic
Font 4	San Serif LQ	Gothic
Font 5	Roman LQ	Courier
Font 6	Script LQ	Courier
Font 7	Prestige LQ	Courier
Font 8	OCRB LQ	OCRB
Font 9	OCRA LQ	OCRA

Right Justification

The 6800 MTPL Emulation supports this feature, though it is not implemented on the MT360. The sequence is described in the MTPL Programmer's Manual.

Underlines

In the 6800 MTPL Emulation, underlines are drawn relative to the vertical positioning of the text (superscript, subscript and microscript specifically), while on the MT360 underlines are always in the same vertical position.

Clearing Tabs on the Current Line

When the 6800 MTPL Emulation receives this sequence, the tabs are cleared for the rest of the current line, and restored on the next one. The MT360 permanently clears the tabs, although that is handled by another sequence.

Select Size Units

The 6800 MTPL Emulation implements the different units described in the MTPL Programmer's Manual, though the MT360 only supports the decipoint unit.

Unprintable Regions

The 6800 MTPL Emulation does not allow the user to print between the bottom margin of one form and the top margin of the next. The MT360 printer allows the user to move backwards into this region and print.

Proportional Print

The 6800 MTPL Emulation supports proportional printing for only Data Processing font at 10 characters per inch. If one of these attributes is different, the text is printed at the normal character horizontal distance.

Optical Character Recognition Fonts

The 6800 OCRA and OCRB fonts do not support non-alphanumeric characters. When the user attempts to print special characters in these fonts (either explicitly or through a language setting), it instead uses Gothic font. Afterwards, the font returns automatically to OCRA or OCRB.

Print Quality

The 6800 MTPL Emulation does not support different print quality modes. Instead, it approximates the effects of high, medium and low print quality through font changes:

Print Quality	Font Substitution
Draft	Data Processing
Fast Draft	Data Processing

Loading Menus

When the 6800 MTPL Emulation receives the "Load Menu" sequence, it changes the configuration to one of the following:

Parameter	Configuration Loaded
0	Default (Tally ANSI emulation is selected)
1	Powerup
2	Alternate
3	Unused
4	Unused

Transparent Escape Sequence

The CSI Pn SP r escape sequence is an undocumented feature of the MT360 printer. It makes each normally unprintable control code (n) into a printable character. The characters printed by each control code are shown in the table below, indexed by nibble:

	0	1	2	3	4	5	6	7	8	9	A	B	C	D	E	F
0	—	°	α	β	∅	ø	¨	Á	Ä	Å	À	ã	È	É	Í	Ì
1	Ö	Õ	Ó	Ò	¶	§	ð	Ú	Û	¹	²	³	⁴	³	Ø	⊖
8	Ç	ü	é	â	ä	à	á	ç	ê	ë	è	ï	î	ì	Ä	Å
9	É	æ	Æ	ô	ö	ò	ù	ú	ÿ	Ö	Ü	ç	£	¥	¤	f

Figure 7 MTPL Printable Control Codes

¹ Uppercase L with dot

² Lowercase L with dot

³ Lowercase Script L

⁴ Lowercase N with apostrophe

Emulation Enhancements

The following escape sequences have been added:

POSTNET bar codes ESC [1 p

PLANET bar codes ESC [2 p

UK Postal 4-State bar codes ESC [1 k

Dutch KIX 4-State bar codes ESC [2 k

PJL

A number of PJL commands have been implemented for use with all emulations except HP2564C when using the LANPlex interface. The primary use for PJL in this firmware is for AS/400 LAN attachment, or other custom applications. The LJ Series line printers should be used for full-featured connectivity in HP environments.

These commands are defined by Printer Job Language Technical Reference Manual, HP Part Number 5961-0938, May 1996. The following PJL commands are supported.

Universal Exit Language (UEL) Commands:

"ESC"%-12345X@PJL

"ESC"%-12345X

@PJL

ECHO Command:

@PJL ECHO

EOJ (End of Job) Commands:

@PJL EOJ

@PJL EOJ NAME=

INFO (Information Request) Command:

@PJL INFO STATUS

RDYMSG (Ready Message) Command:

@PJL RDYMSG DISPLAY =

USTATUS (Unsolicited Status) Commands:

@PJL USTATUS DEVICE = ON

@PJL USTATUS DEVICE = OFF

@PJL USTATUS DEVICE = VERBOSE

@PJL USTATUS JOB = ON

@PJL USTATUS JOB = OFF

@PJL USTATUS PAGE = ON

@PJL USTATUS PAGE = OFF

@PJL USTATUSOFF

JOB (Start of Job) Commands:

@PJL JOB NAME =

@PJL JOB FILE =

@PJL JOB START =

@PJL JOB END =

@PJL JOB COPY =

2 ***Graphics Language Emulations***

Graphics languages are a set of commands used to create graphic images such as large characters, lines, boxes, and bar codes. A graphics language in the 6800 Series software is run on top of one or more underlying control languages.

MT660 Industrial Graphics

This graphics language is an emulation of the MT660 Industrial Graphics option, as defined by MT Manual Number 243, Bar Code/Block Character Applications Manual. It is accessible only from the native ANSI emulation. The commands are defined in Manual Number 255557-001, Graphics Applications Manual, Line Printers.

QMS Code V

This graphics language is an emulation of QMS Code V Version 1 and 2. It is accessible from all underlying control languages.

The emulation is based on QMS Manual Number 1720155B, QMS Code V Version II Programming Manual. The commands are defined in Manual Number 255557-001, Graphics Applications Manual, Line Printers.

Printronix Graphics Language

The Printronix Graphics Language (PGL) emulation provides a graphics language that is compatible with the Printronix IGP 100/200/400 language. It is accessible from all underlying control languages.

The emulation is based on IGP-100 Firmware Version 2.19A (Part Number 148771,) and the Printronix IGP-100 Manual (Part Number 141331-001 Revision A.) In cases where the function of the firmware differs from the manual, the emulation follows the function of the firmware. The commands are defined in Manual Number 255557-001, Graphics Applications Manual, Line Printers.

3 *Intellifilter*

Intellifilter is a programmable feature that permits users to free their systems from hard coded dependence on a specific printer that is no longer maintainable, or able to meet the demands of the application.

A filter monitors the incoming data stream for specified character sequences (strings). When it detects a specified string, it can delete it, substitute or insert another string, and/or pass control to another filter. The main purposes of a filter are to strip unwanted strings, to replace strings with strings compatible with the printer, and to insert commands that modify the presentation of the data that follow.

Filter Structure and Logic

A filter contains one or more action segments. Each segment defines one target and the actions to take upon matching it. Generally the order of the segments within the filter is inconsequential.

Each action segment is composed of the mandatory command, TARGET, followed by at least one and no more than two optional commands, within which there can be no more than one exclusive command. If CHANGE- FILTER is present, it must be last.

Table 23 Intellifilter Commands

Command	Mandatory/ Optional	
TARGET "string"	Mandatory	Specifies a string to be sought within the incoming data stream.
DELETE	Exclusive & Optional	Removes each occurrence of the TARGET string from the data stream.
INSERT "string"	Exclusive & Optional	Adds the specified string after each occurrence of the TARGET string.
PRECEDE "string"	Exclusive & Optional	Replaces the specified string before each occurrence of the TARGET string with the specified string.
REPLACE "string"	Exclusive & Optional	Replaces the specified string before each occurrence of the TARGET string with the specified string.
CHANGE-FILTER NEWFLTR.CFG	Optional	Transfers control of the Intellifilter to the specified filter.

The nine valid action segments in a filter are:

Table 24 Filter Action Segments

TARGET "string1" DELETE	TARGET "string1" INSERT "string2"	TARGET "string1" "PRECEDE "string2"	TARGET "string1" REPLACE "string2"
TARGET "string1" DELETE	TARGET "string1" INSERT "string2"	TARGET "string1" PRECEDE "string2"	TARGET "string1" REPLACE "string2"
CHANGE-FILTER TARGET "string1" CHANGE-FILTER	CHANGE-FILTER X.CFG	CHANGE-FILTER X.CFG	CHANGE-FILTER X.CFG
X.CFG			

Filter Procedure for Matching Targets

With each byte of data received, Intellifilter makes a comparison to the first byte of each action segment's target string. Intellifilter drops the targets that do not match the first byte and looks ahead to the next data byte, comparing it to the second byte of each surviving target. As before, it drops those targets that fail.

If a target completes its match, Intellifilter designates it as a candidate winner, and continues the process until all targets have either failed, or succeeded to be candidate winners. At this point, Intellifilter designates the ultimate winner to be the longest target among the candidate winners. It takes the action prescribed for that target, and releases all data bytes up to and including those that contributed to the winning match. Those bytes are no longer available to Intellifilter.

Target Matching Rules

1. The successful target that began its match first wins over any others.
2. When multiple successful targets began their matches at the same time, the longest one wins.
3. When multiple successful targets of the same length began their match at the same time, the first one listed in Intellifilter wins. (This is the only time when order within the filter matters.)
4. Data stream characters are used only once. When a target is matched resulting in an action, all characters in the data stream used to find the match are released from Intellifilter and are no longer available for additional matching.

The following Table 25 shows examples that illustrate multiple successful target matching rules:

Table 25 Intellifilter Examples

Example	Intellifilter Input Data	Data	Rule
TARGET "DEFG" INSERT "X"	ABCDEFGH	ABCDEFYGH	1. Y wins because it began first. If it had ultimately failed, X would have won. If X had ultimately failed, Z would have won.
TARGET "E" INSERT "Z" TARGET "DEFGI" INSERT "X"	ABCDEFGH	ABCDEFYGH	2. X ultimately fails so Y wins because it is longer than Z.
TARGET "D" INSERT "Z" TARGET "DEFG" INSERT "X"	ABCDEFGH	ABCDEFGXH	3. X wins because it is listed first in the filter.
TARGET "DEF?" INSERT "Y" TARGET "DEFG" INSERT "X"	ABCDEF1H	ABCDEF1YH	3. In the above example, the only time Y can win is when X fails.
TARGET "DEF?" INSERT "Y" TARGET "BCDB" INSERT "X"	ABCDBCDBCDBC	ABCDBXCDBCDBXC	4. Only two matches found.

Building, Testing, and Implementing Intellifilter

1. Capture and analyze all data files that will be sent to the printer.
2. Design and write the filter files in a comprehensive text editor. Make sure the filter is sufficiently discriminating that it not only works correctly on the files that require action, but that it does not false on any other file that comes to the printer.
3. Test the filter against the captured data, using IFILTER.EXE, a DOS- based program that simulates the Intellifilter function of the printer. Verify the result by viewing the resulting output file in the editor, and/or by sending it to the printer.

When satisfied, install the Intellifilter in the printer as follows:

4. Make a command file that indicates whether the files are to go to flash or hard disk, and that names all the files in the suite.
5. Run BUILDLOD.EXE which reads the command file, and builds the composite OUTPUT.LOD file.
6. Set up the printer to accept an Intellifilter download (see Operator Manual) and send OUTPUT.LOD directly to the printer to install the filter suite.

7. Send the captured data files to the printer to verify correct operation.

IFILTER.EXE

By simulating the Intellifilter logic in the printer, IFILTER.EXE permits rapidly testing filter designs. IFILTER.EXE reads an Intellifilter file suite, plus a data file, and produces an output file based on the actions commanded. IFILTER.EXE runs under DOS on a PC. All input and output files are in the default (current) directory.

The output of IFILTER.EXE is IFILTER.OUT, a file which can be analyzed in a text editor, or sent to a printer to verify the result. IFILTER.EXE also reports status and errors related to the filtering operation. These include parsing of the configuration files as well as the actual data filtering.

The command is:

```
IFILTER MASTER-CONFIG-FILE DATA-STREAM-FILE (Y|N)
```

strip-ctrl-d: N = no (default, Y = yes

When the master configuration file is loaded into the printer, it must be named FMASTER.CFG, but a different name, for example TEST.CFG, can be used with IFILTER.EXE. Be sure either to rename or copy it to FMASTER.CFG before compiling it.

If the master configuration file calls other filter files, you do not need to name them. IFILTER.EXE will identify them by following all the chains.

DATA-STREAM-FILE is the name of the file to be acted upon. The contents of this file will be modified by the commands of the Intellifilter suite, and the result written in IFILTER.OUT.

BUILDL0D.EXE

BUILDL0D.EXE is a DOS-Based program that combines and compiles individual files into a single file, OUTPUT.L0D, which serves as a vehicle to directly transfer them into a TallyGenicom printer's non-volatile storage.

The command is BUILDL0D FILELIST.CMD

1. The command file can have any name and extension, but usually is given a name related to the customer or application, and with a .CMD extension.
2. Files named in FILELIST.CMD will be processed by BUILDL0D.EXE and incorporated into OUTPUT.L0D
3. The main Intellifilter file must be named FMASTER.CFG.

Command File Structure:

FILELIST.CMD

FORMAT

TYPE OTHER

INPUT CONTINUE.CFG

The FORMAT command is required if it is desired to format the flash file system prior to loading the files.

The TYPE OTHER indicates flash memory which is the only storage option for line printers.

A *Contact Information*

TallyGenicom Customer Support Center

IMPORTANT Please have the following information available prior to calling the TallyGenicom Customer Support Center:

- Model number
- Serial number (located on the back of the printer)
- Installed options (i.e., interface and host type if applicable to the problem)
- Configuration printout: (See “Printing A Configuration”) in your printers Administrator’s manual.
- Is the problem with a new install or an existing printer?
- Description of the problem (be specific)
- Good and bad samples that clearly show the problem (faxing or emailing of these samples may be required)

Americas	(714) 368-2686
Europe, Middle East, and Africa	(31) 24 6489 311
Asia Pacific	(65) 6548 4114
China	(86) 800-999-6836

<http://www.tallygenicom.com/service/default.aspx>

TallyGenicom Supplies Department

Contact the TallyGenicom Supplies Department for genuine TallyGenicom supplies.

Americas	(800) 733-1900
Europe, Middle East, and Africa	(33) 1 46 25 19 07
Asia Pacific	(65) 6548 4100
China	(86) 400-886-5598
India	1800 102 7869

<http://www.tallygenicom.com/supplies/default.aspx>

Corporate Offices

Printronic, LLC.
15345 Barranca Parkway
Irvine, CA 92618
U.S.A.
Phone: (714) 368-2300
Fax: (714) 368-2600

Printronic LLC.
c/o Printronix Nederland BV
Bijsterhuizen 11-38
6546 AS Nijmegen
The Netherlands
Phone: (31) 24 6489489
Fax: (31) 24 6489499

Printronic Schweiz GmbH
3 Changi Business Park Vista
#04-05 AkzoNobel House
Singapore 486051
Phone: (65) 6548 4100
Fax: (65) 6548 4111

Printronic Commercial (Shanghai) Co. Ltd.
Room 903, 9th Floor
No. 199, North Xizang Road
200070 Shanghai P.R. China
Phone: (86) 400 886 5598
Fax: (8621) 61171256

Printronic India Pvt Ltd
B-808/809, BSEL Tech Park
8th Floor, Sector 30A
Vashi Navi Mumbai 400705
India
Toll Free No.: 1800 102 7896
Fax: (9122) 4158 5555

Visit the web site at www.tallygenicom.com

256672 B